



# Global Infrastructure Index

## Public satisfaction and priorities – 2018

Global

\*embargoed – 29 November 2018

00.01 GMT





# The Global Infrastructure Index

# Introduction

- These are the findings of the third **Global Infrastructure Index** conducted via Ipsos' Global @dvisor between **24 August – 7 September 2018** in **29 countries** around the world via the Ipsos Online Panel system and involving **20,286** participants:

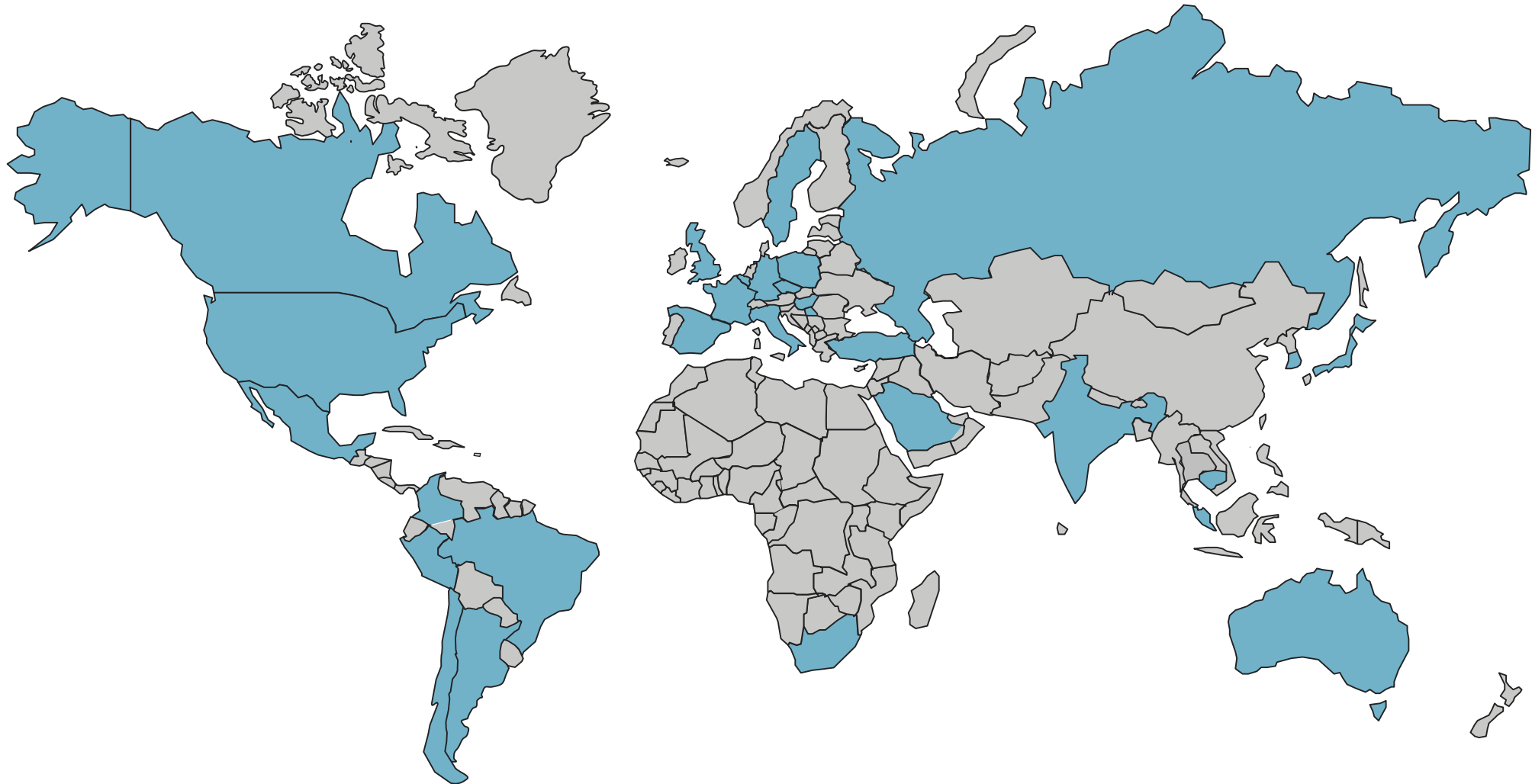

# Methodology

- 28 countries, **19,786** participants:  
Argentina, Australia\*, Belgium, Brazil, Canada\*, Chile, Colombia, France\*, Germany\*, Great Britain\*, Hungary, India\*, Italy\*, Japan\*, Malaysia, Mexico, Peru, Poland, Russia, Saudi Arabia, South Africa, South Korea, Serbia, Spain\*, Sweden, Turkey and the United States of America\*  
*\* denotes 1,000+ sample size*
- Independently of Global @dvisor, 500 participants were sampled in the **Czech Republic**. Results have been shown in comparative tables but are **not** included in 'global' nor 'Europe' data.
- Participants were adults aged 18-64 in the US and Canada, 18-65 in Czech Republic and adults aged 16-64 in all other countries.
- Results may not sum to 100% and combinations to their constituent %s (e.g. very/fairly satisfied) due to computer rounding.
- The 2016 and 2017 surveys used the same methodology, but the profile of participating countries changed in both years. This means that the **global trend** does not involve a like-for-like comparison. Please note that the survey was also undertaken additionally in the Czech Republic, but results for this country are **not** included in Global totals.
- A selection of trends is included. Further information (with a GB focus) is available:

<https://www.ipsos.com/ipsos-mori/en-uk/rail-joins-housing-top-infrastructure-priorities-britons> (2017)

<https://www.ipsos.com/ipsos-mori/en-uk/do-more-poll-shows-britons-behind-action-infrastructure> (2016)

# Regions

## & sample sizes

### Europe\*

**8,541**

Belgium  
France  
Germany  
Great Britain  
Hungary  
Italy  
Poland  
Romania  
Serbia  
Spain  
Sweden

\* *excluding Czech Republic*



### N. America

**2,001**

Canada  
U.S.A.

### LATAM

**3,577**

Argentina  
Brazil  
Chile  
Colombia  
Mexico  
Peru

### APAC

**4,156**

Australia  
India  
Japan  
Malaysia  
South Korea

### G8

**7,678**

Canada  
France  
Germany  
Great Britain  
Italy  
Japan  
Russia  
U.S.A.

### BRIC

**2,504**

Brazil  
India  
Russia

### ME Africa

**1,508**

Saudi Arabia  
South Africa  
Turkey

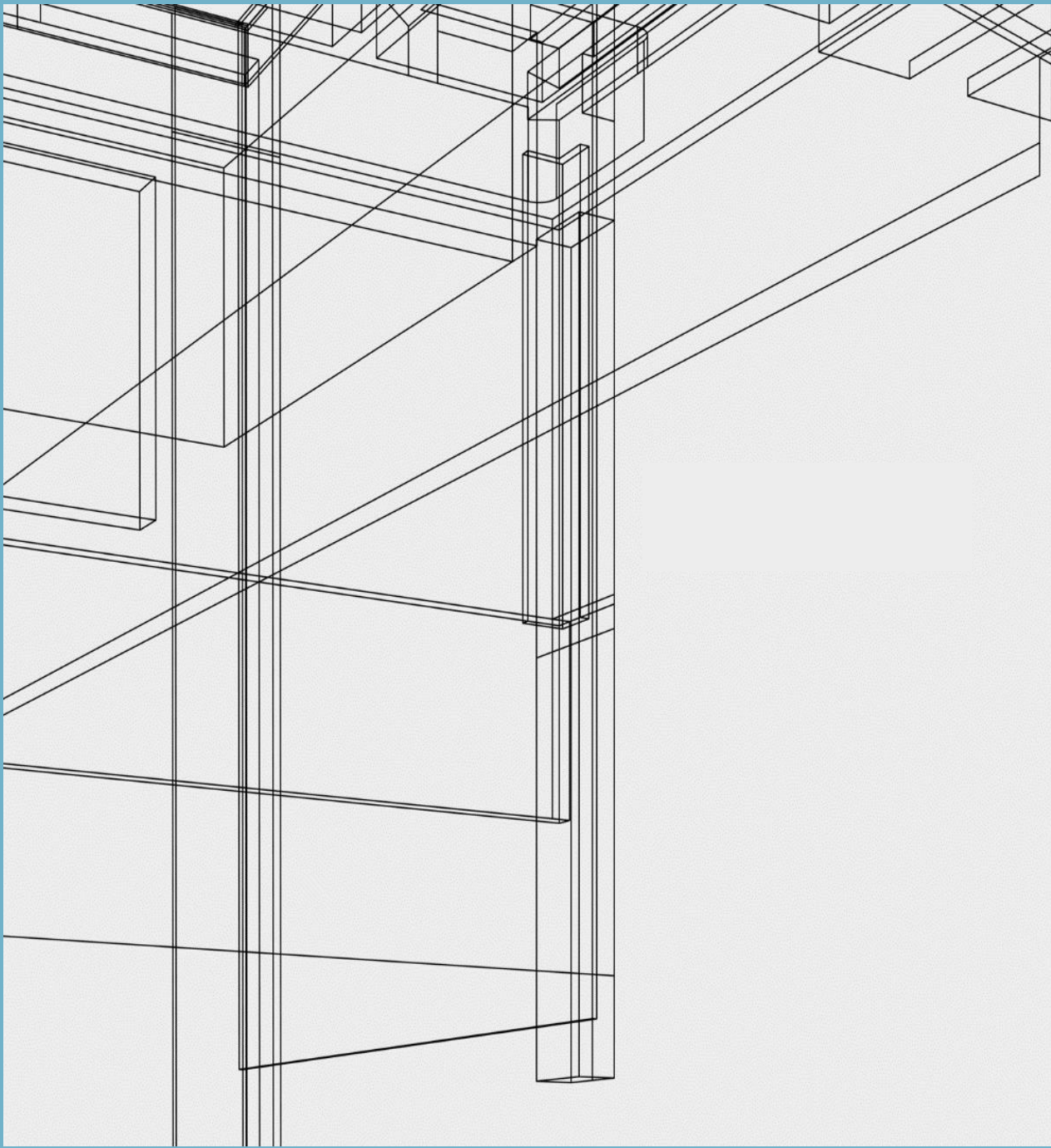

**Overall  
ratings**

# Global and Regions: Overall ratings

**Q. I now want you to think about [COUNTRY'S] infrastructure.**

**By infrastructure I mean things we rely on like road, rail and air networks, utilities such as energy and water, and broadband and other communications.**

**Overall, how satisfied or dissatisfied are you with [COUNTRY'S] national infrastructure?**

■ % Very/fairly satisfied

■ % Very/fairly dissatisfied

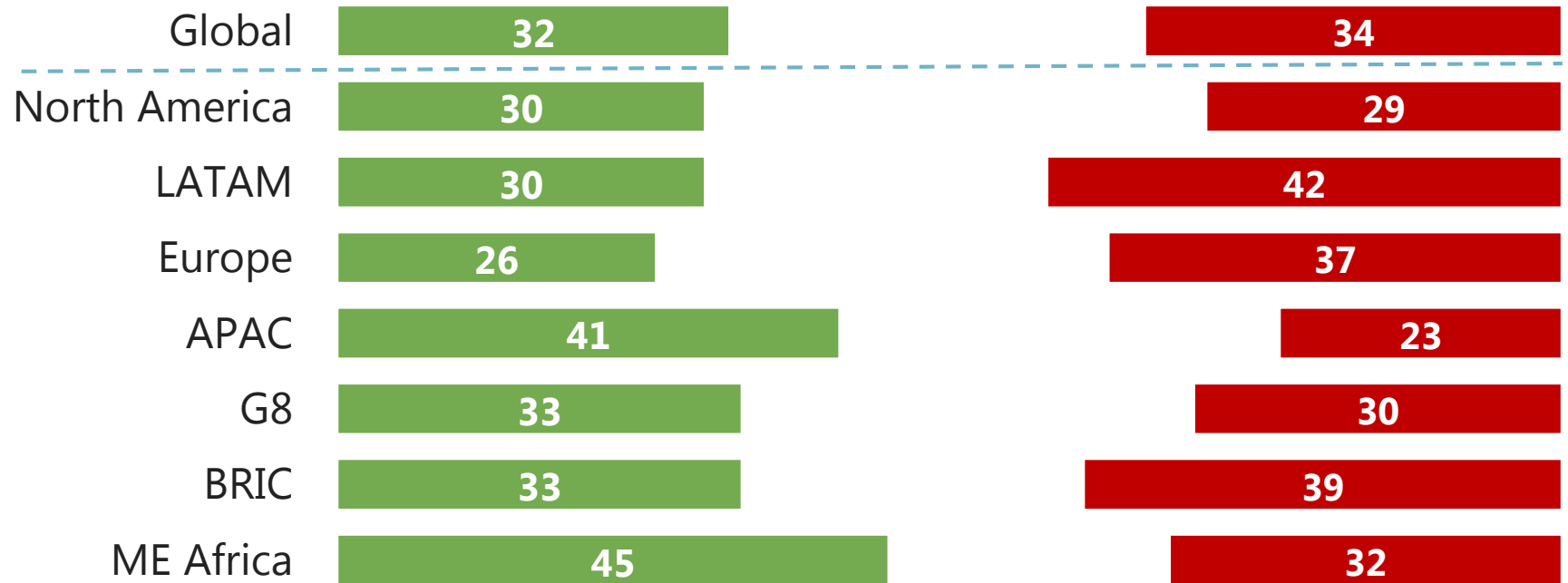

% very/fairly satisfied

Source: Ipsos/ GIIA

Base: 19,786 adults (online), Aug-Sept 2018

# Trends: Overall ratings

**Q. I now want you to think about [COUNTRY'S] infrastructure.**

**By infrastructure I mean things we rely on like road, rail and air networks, utilities such as energy and water, and broadband and other communications.**

**Overall, how satisfied or dissatisfied are you with [COUNTRY'S] national infrastructure?**

**% very/fairly satisfied**

The 2016-18 surveys used the same methodology, but the profile of participating countries changed between years. This means that the **global and regional trends** do not always involve a strict like-for-like comparison.

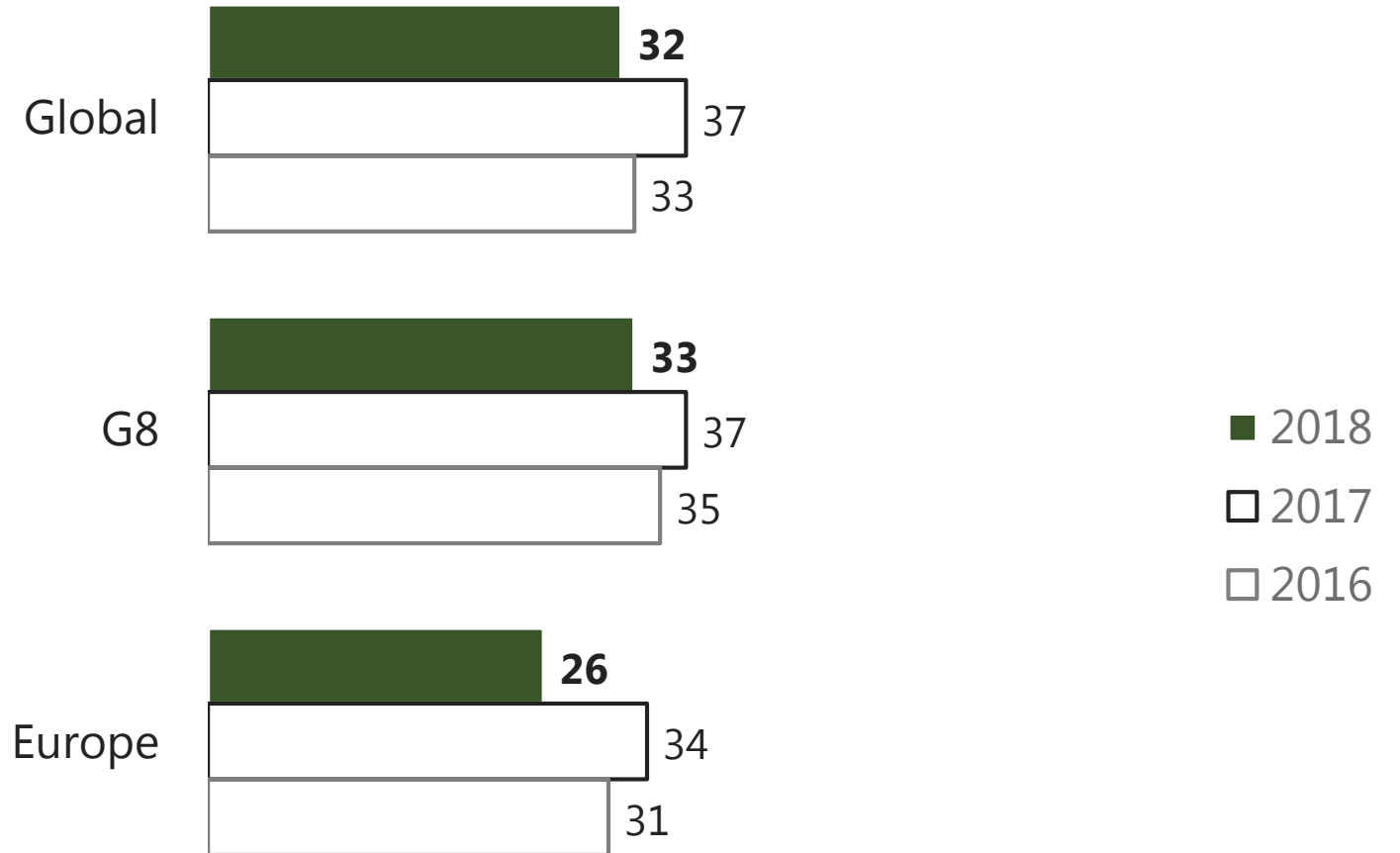

Source: Ipsos/ GIIA

Base: 19,786 adults (online), Aug-Sept 2018



# Global: Overall

**Q. I now want you to think about [COUNTRY'S] infrastructure.**

**By infrastructure I mean things we rely on like road, rail and air networks, utilities such as energy and water, and broadband and other communications.**

**Overall, how satisfied or dissatisfied are you with [COUNTRY'S] national infrastructure?**

**% very/fairly satisfied**

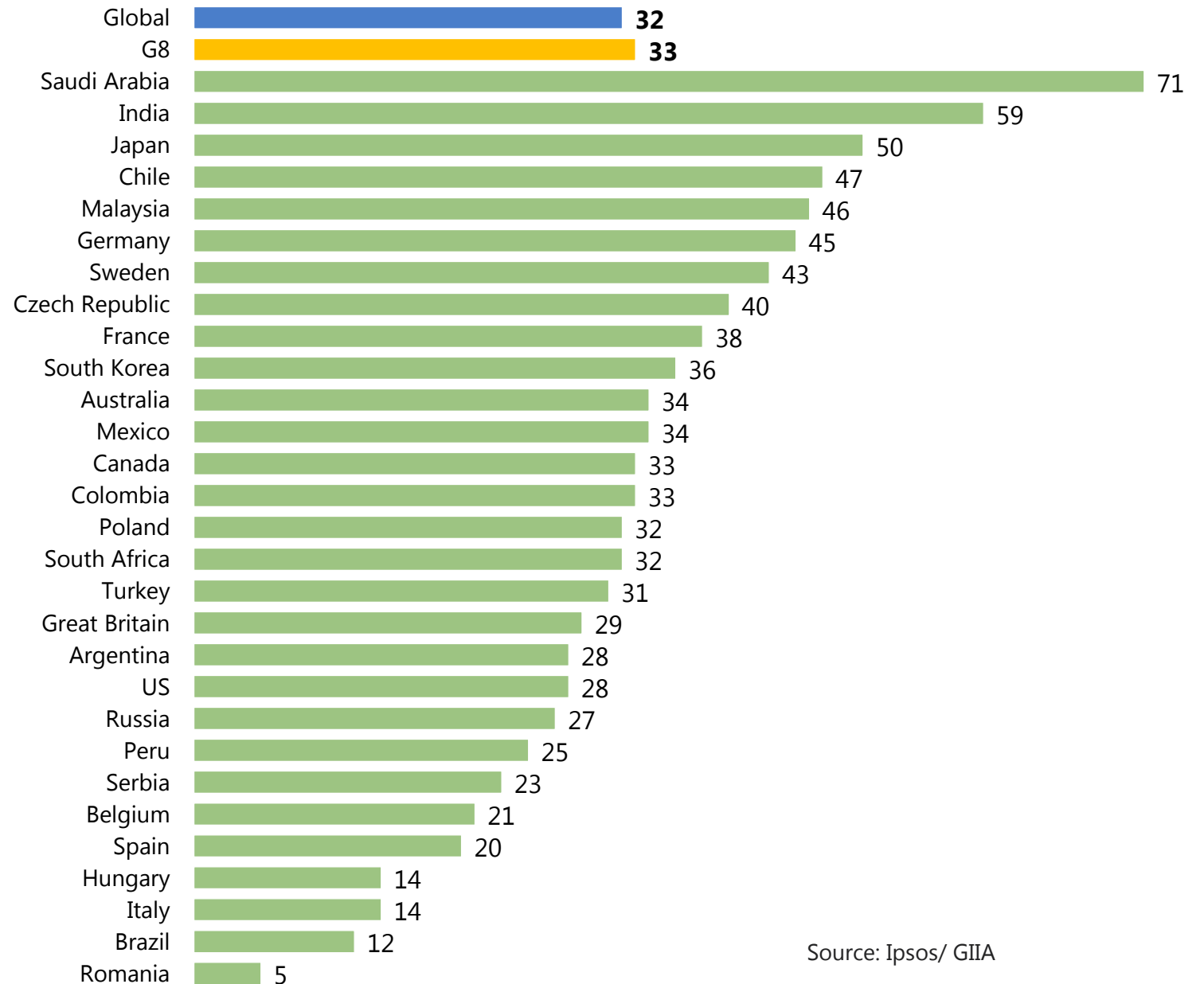

Source: Ipsos/ GIIA

Base: 19,786 adults (online), Aug-Sept 2018

# Global: Overall

**Q. I now want you to think about [COUNTRY'S] infrastructure.**

**By infrastructure I mean things we rely on like road, rail and air networks, utilities such as energy and water, and broadband and other communications.**

**Overall, how satisfied or dissatisfied are you with [COUNTRY'S] national infrastructure?**

**% very/fairly dissatisfied**

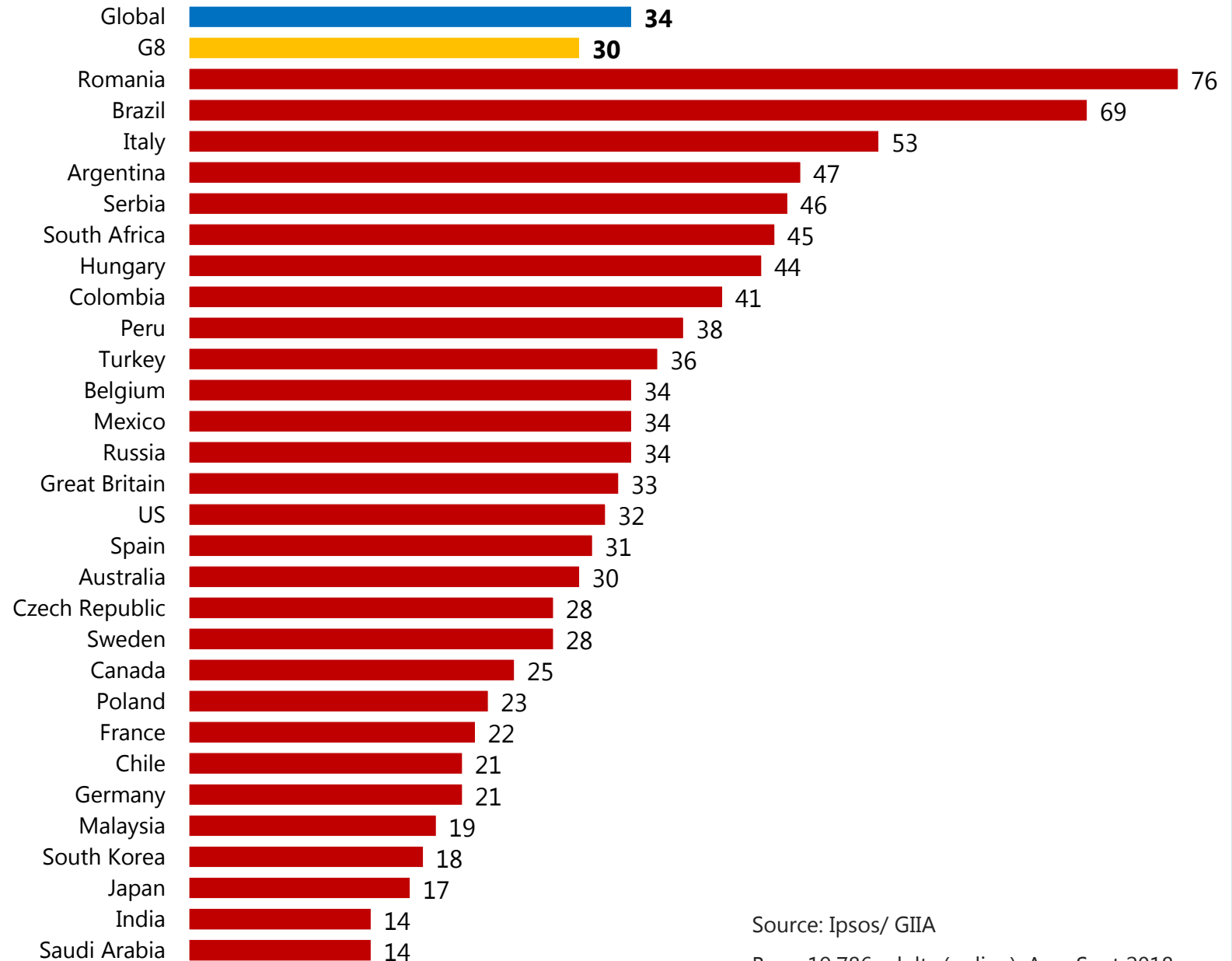

Source: Ipsos/ GIIA

Base: 19,786 adults (online), Aug-Sept 2018

# Trends: Overall

**Q. I now want you to think about [COUNTRY'S] infrastructure.**

**By infrastructure I mean things we rely on like road, rail and air networks, utilities such as energy and water, and broadband and other communications.**

**Overall, how satisfied or dissatisfied are you with [COUNTRY'S] national infrastructure?**

**% very/fairly dissatisfied**

The 2016-18 surveys used the same methodology, but the profile of participating countries changed between years. This means that the **global and regional trends** do not always involve a strict like-for-like comparison.

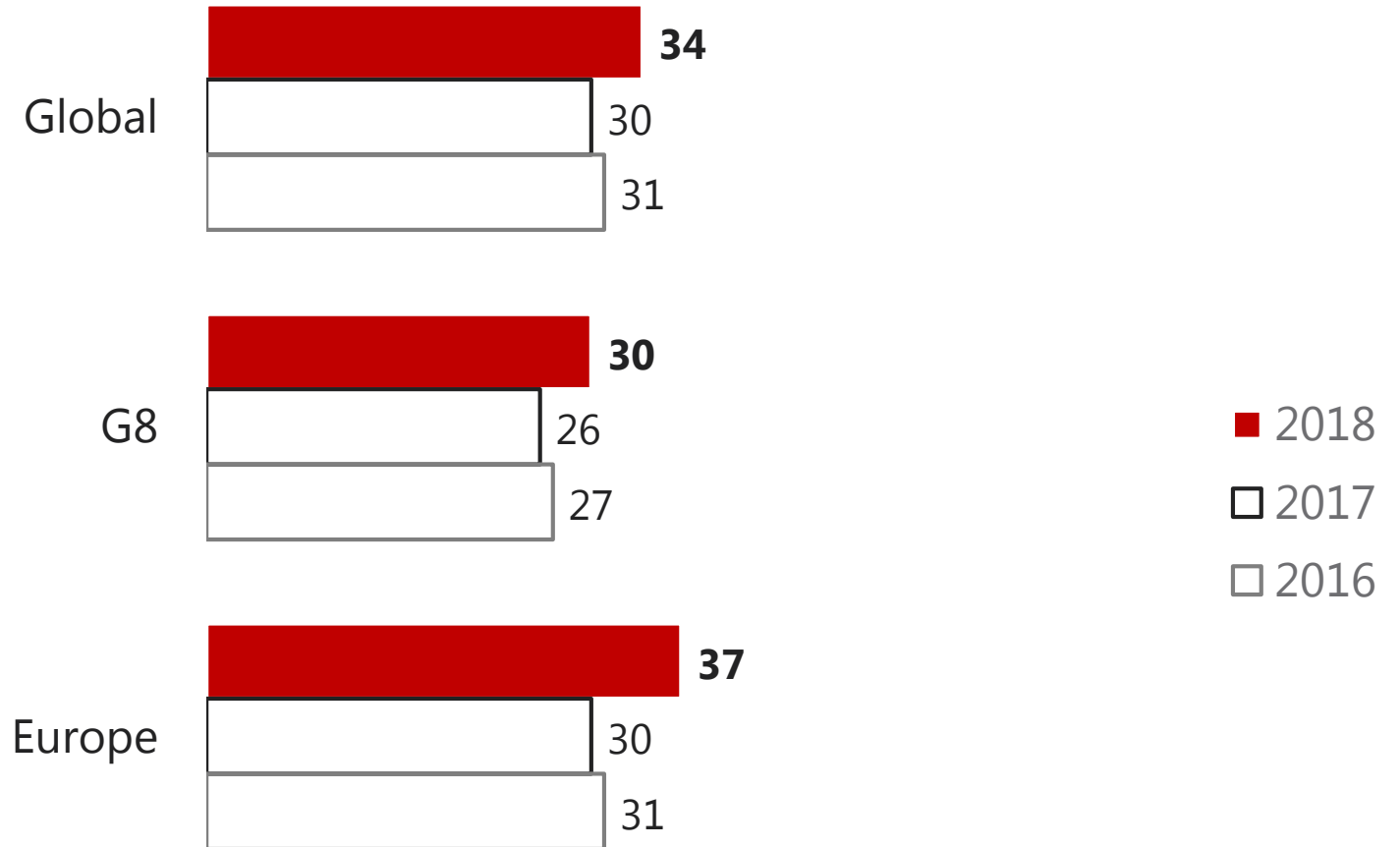

Source: Ipsos/ GIIA

Base: 19,786 adults (online), Aug-Sept 2018

# G8: Overall ratings v GCI

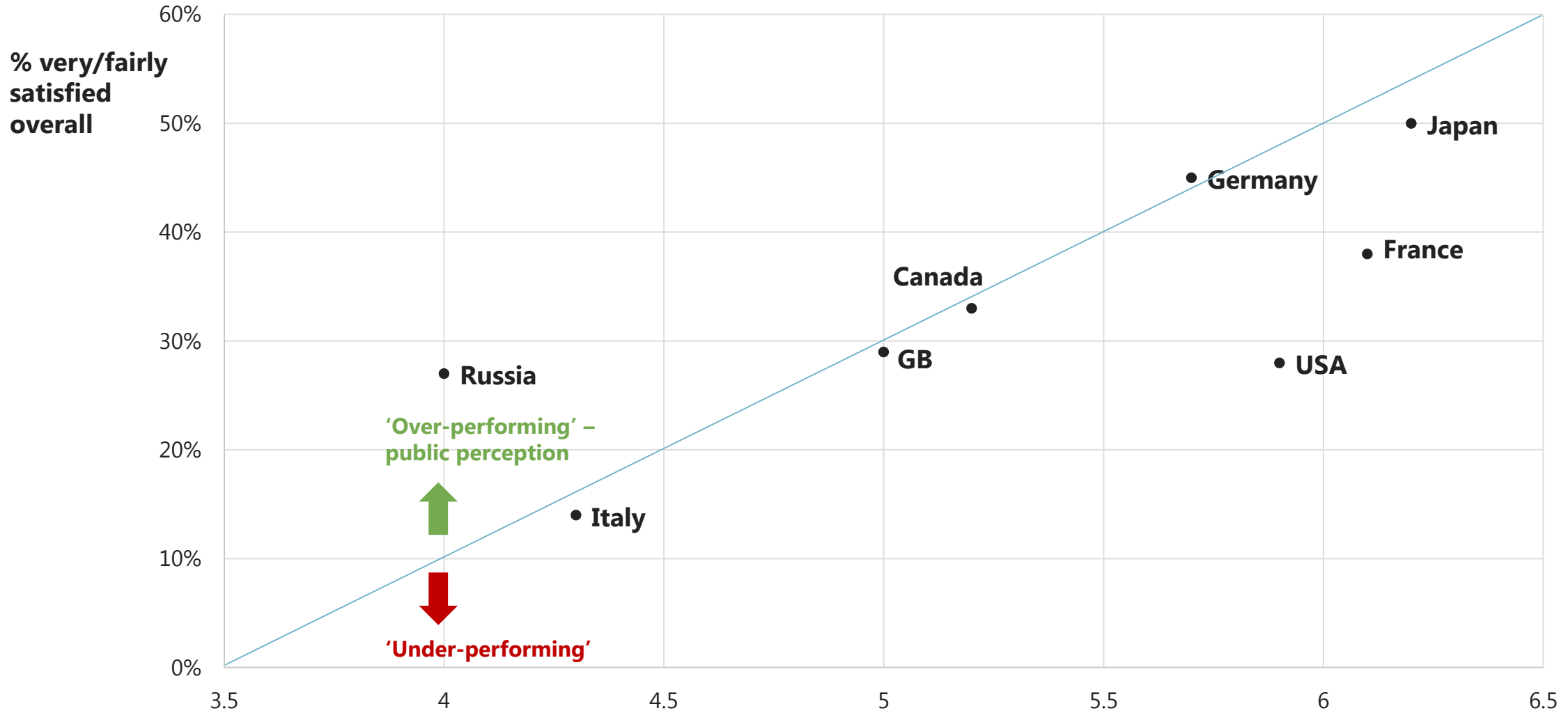

\* Source: The World Economic Forum's Global Competitiveness Report 2017-2018. The chart shows the GCI rating (2.01) for "infrastructure overall" (1-7 where 7=best).

**GCI - Global Competitiveness Index (2.01)\***



Source: Ipsos/ GIIA

Base: 19,786 adults (online), Aug-Sept 2018

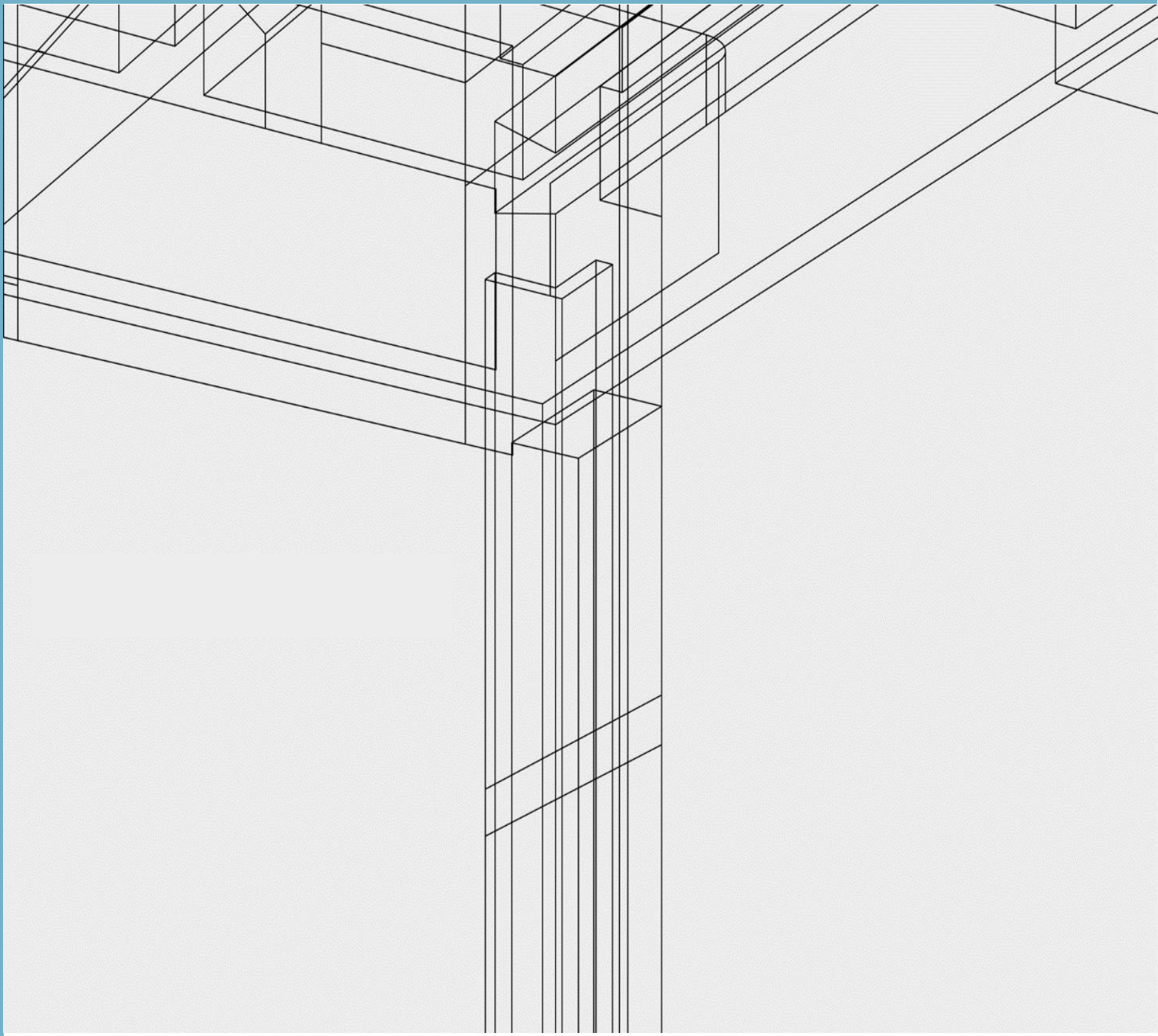

**Sectors –  
ratings**

# Global: Sectors

**Q. These next questions are about different types of infrastructure.**

**Please indicate how good or poor you rate the current quality of each one in [COUNTRY]...**

■ % Very/fairly good

■ % Fairly/very poor

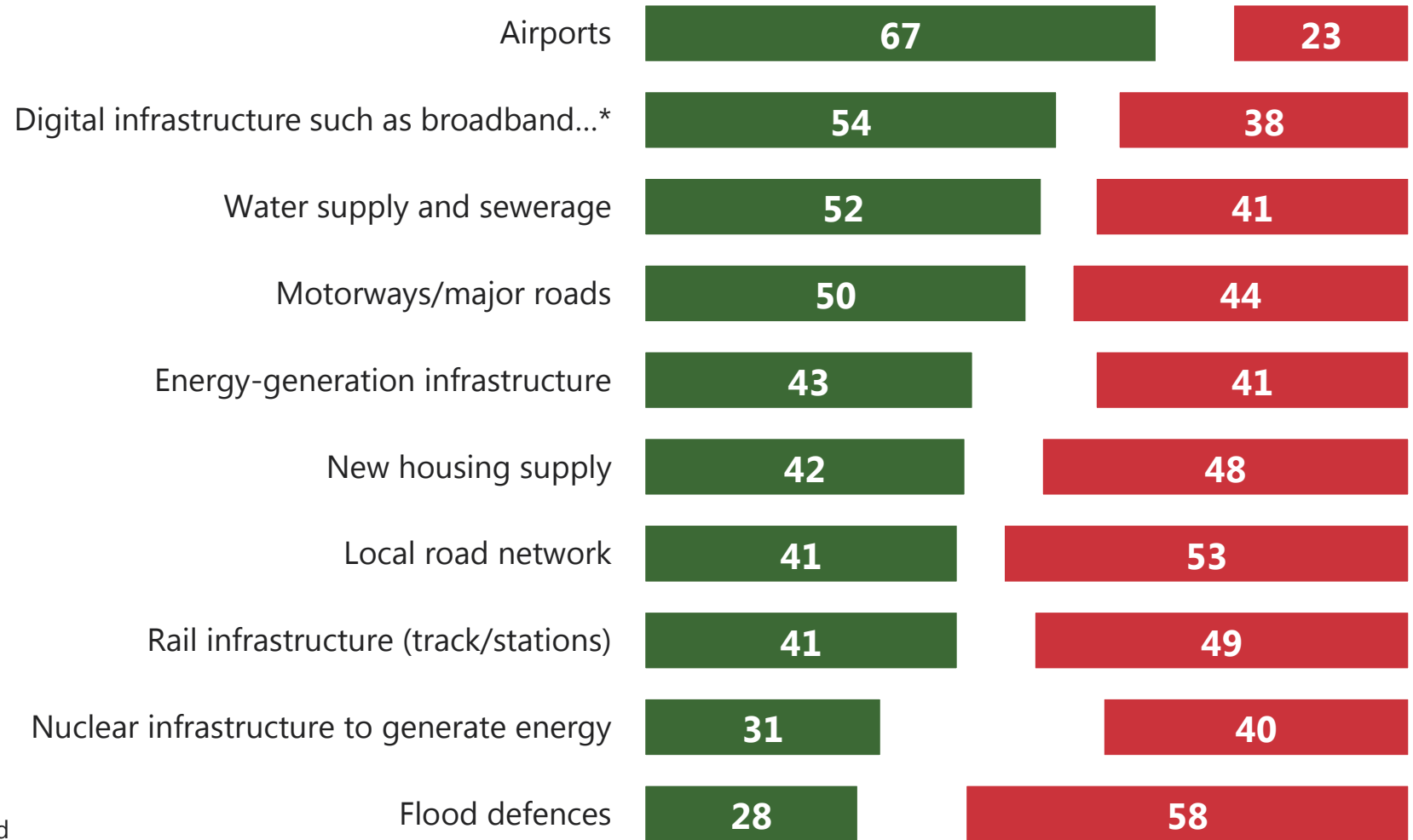

\* Asked as 'Digital infrastructure such as high speed broadband' in 2016 and 2017 and 'Digital infrastructure such as high speed broadband, full fibre networks (FTTP), 5G' in 2018



Source: Ipsos/ GIIA

Ranked by % very/fairly good  
Base: 19,786 adults (online), Aug-Sept 2018

# G8: Sectors

**Q. These next questions are about different types of infrastructure.**

**Please indicate how good or poor you rate the current quality of each one in [COUNTRY]...**

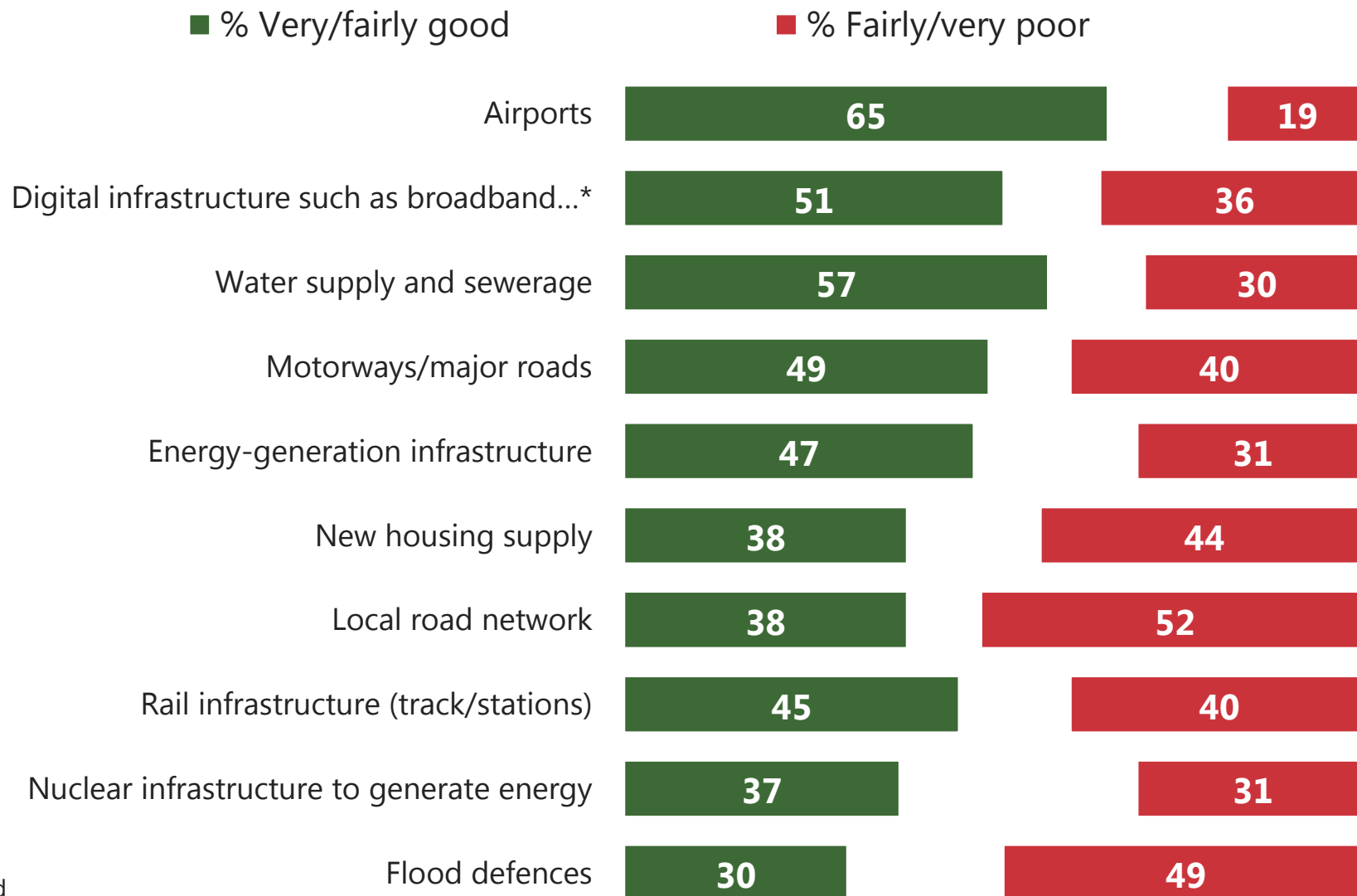

\* Asked as 'Digital infrastructure such as high speed broadband' in 2016 and 2017 and 'Digital infrastructure such as high speed broadband, full fibre networks (FTTP), 5G' in 2018



Source: Ipsos/ GIIA

Ranked by % very/fairly good (global)  
Base: 19,786 adults (online), Aug-Sept 2018

# G8: Sector ratings – trends

**Q. These next questions are about different types of infrastructure.**

**Please indicate how good or poor you rate the current quality of each one in [COUNTRY]...**

**% very/fairly good**

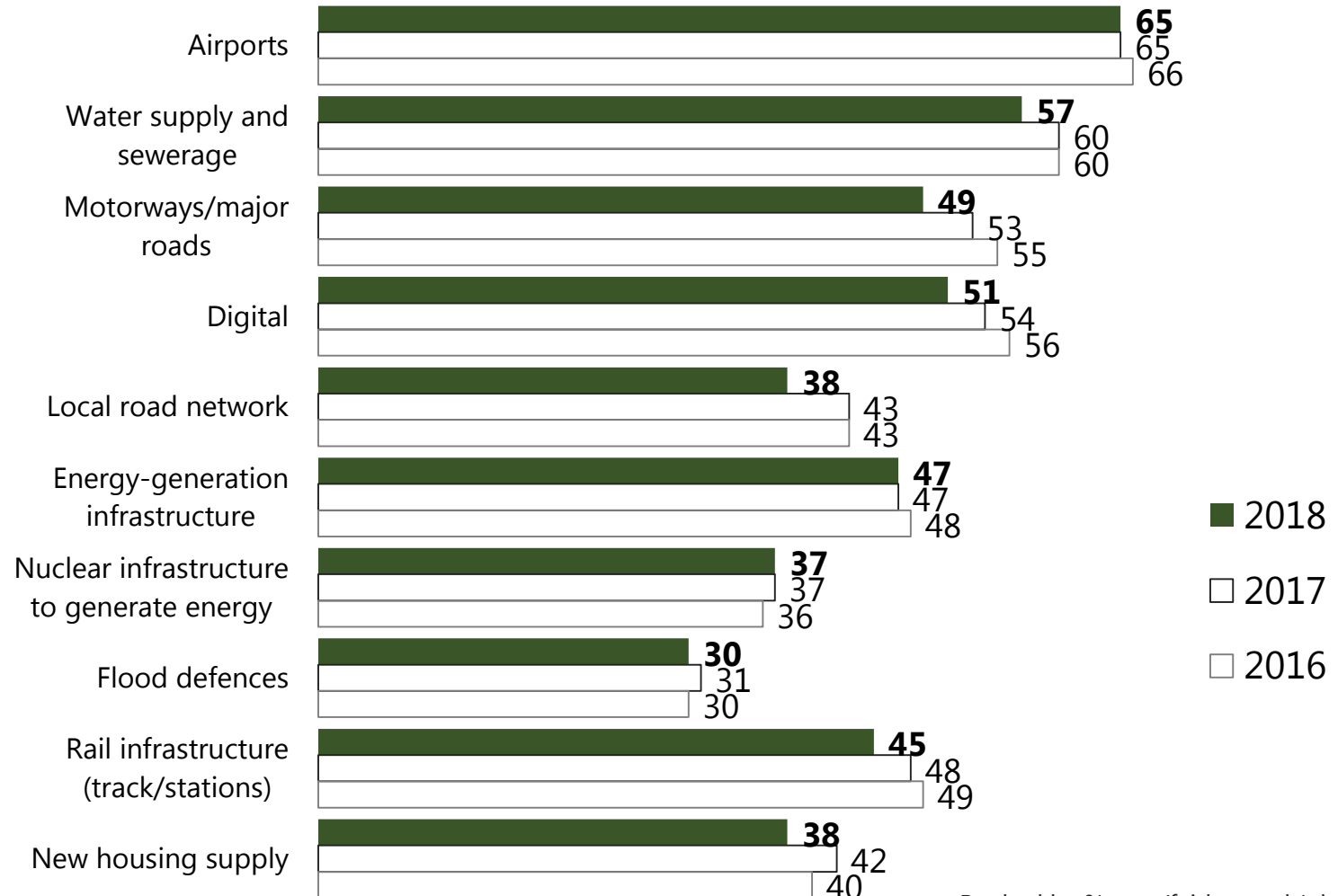

Ranked by % very/fairly good (global, 2018)  
Base: 19,786 adults (online), Aug-Sept 2018



# G8: Sector ratings – trends

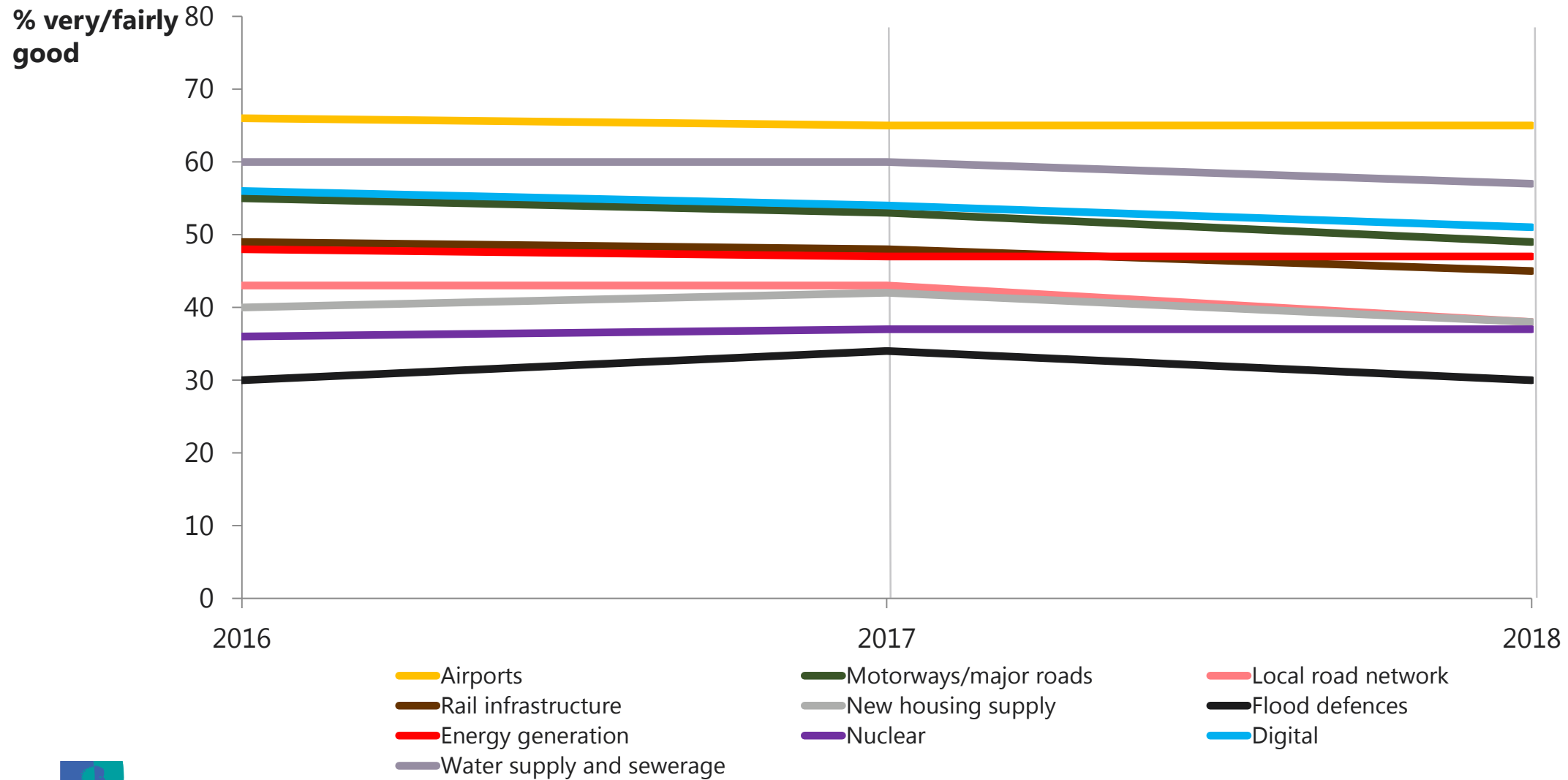

Source: Ipsos/ GIIA

Base: 19,786 adults (online), Aug-Sept 2018

# G8: Overall ratings v average sector ratings

% very/fairly good - sector average

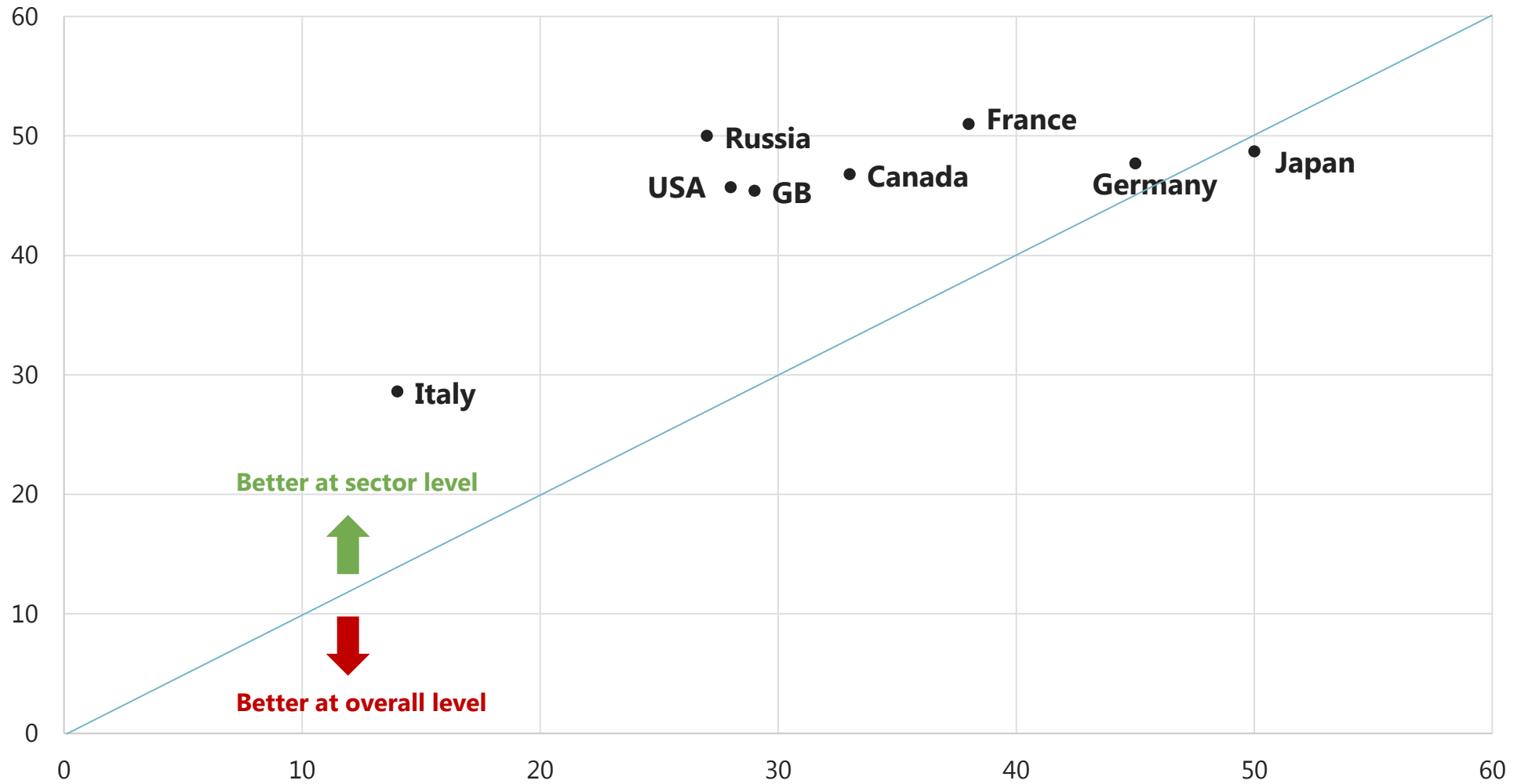

% very/fairly satisfied - overall



Source: Ipsos/ GIIA

Base: 19,786 adults (online), Aug-Sept 2018

# Airports

**Q. These next questions are about different types of infrastructure. Please indicate how good or poor you rate the current quality of each one in [COUNTRY]...**

## Airports

% very/fairly good

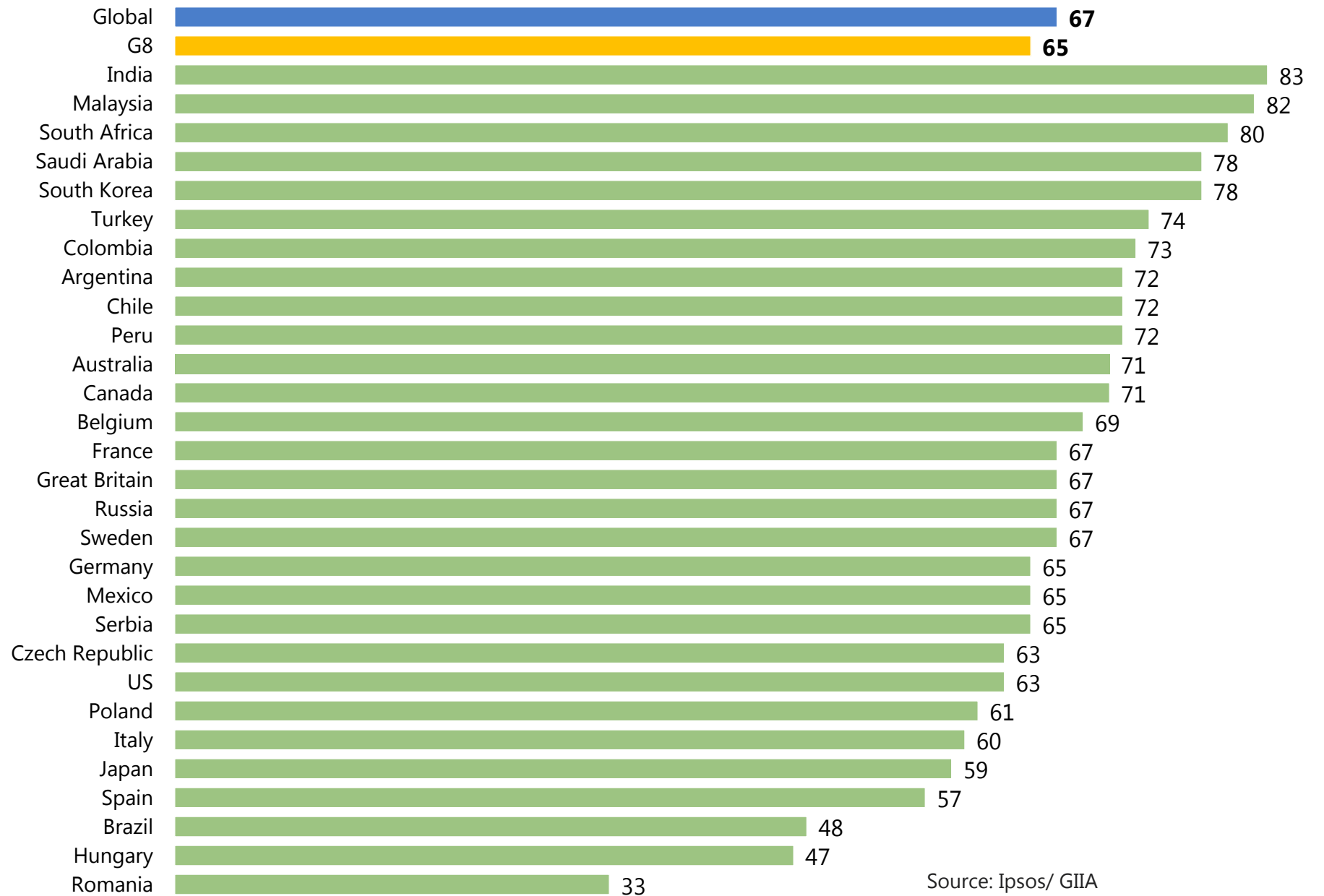

Source: Ipsos/ GIIA

Base: 19,786 adults (online), Aug-Sept 2018

# Motorways

**Q. These next questions are about different types of infrastructure. Please indicate how good or poor you rate the current quality of each one in [COUNTRY]...**

**Motorways/  
major roads**

**% very/fairly good**

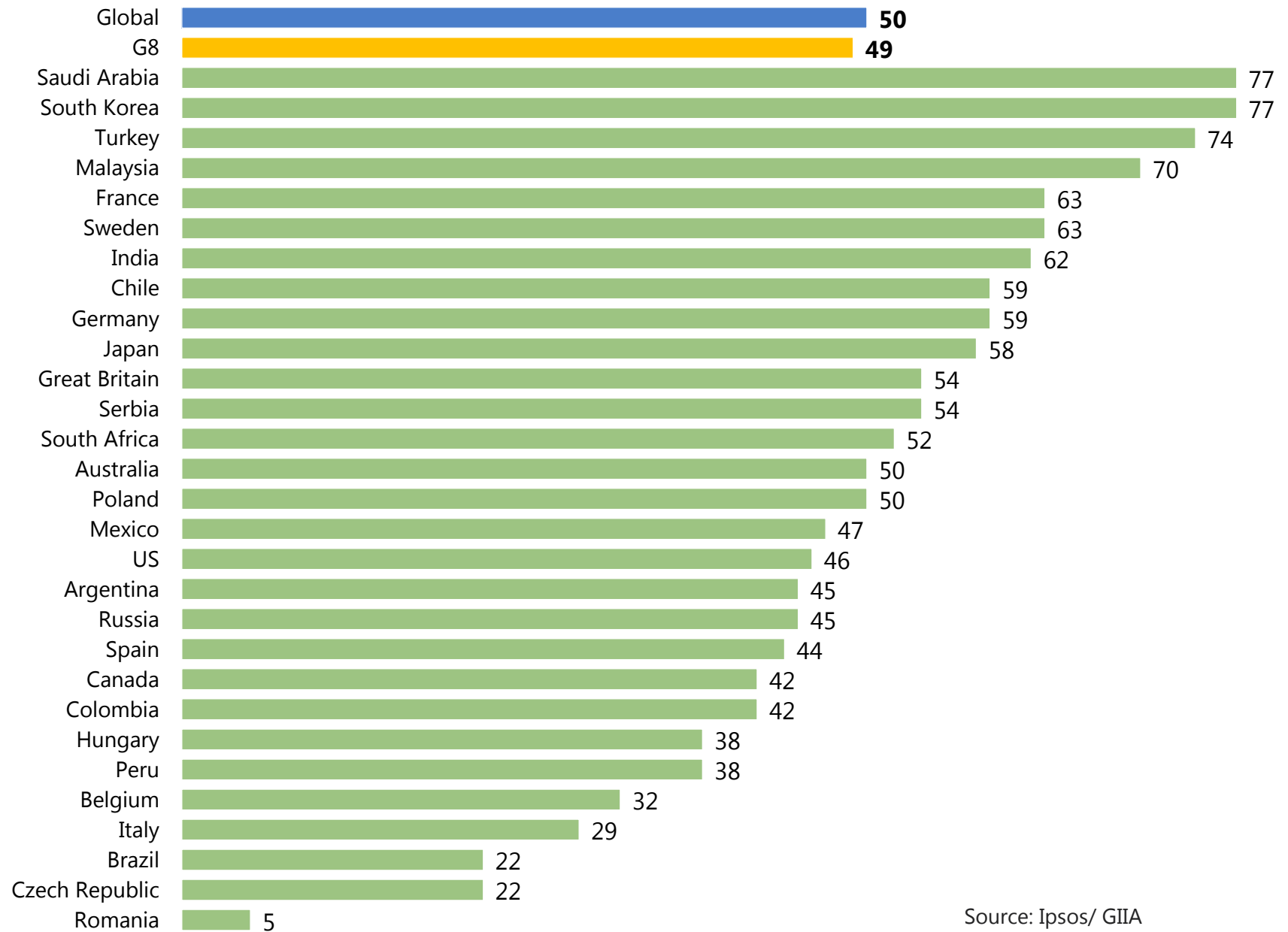

Source: Ipsos/ GIIA

Base: 19,786 adults (online), Aug-Sept 2018

# Local roads

**Q. These next questions are about different types of infrastructure. Please indicate how good or poor you rate the current quality of each one in [COUNTRY]...**

## Local road network

**% very/fairly good**

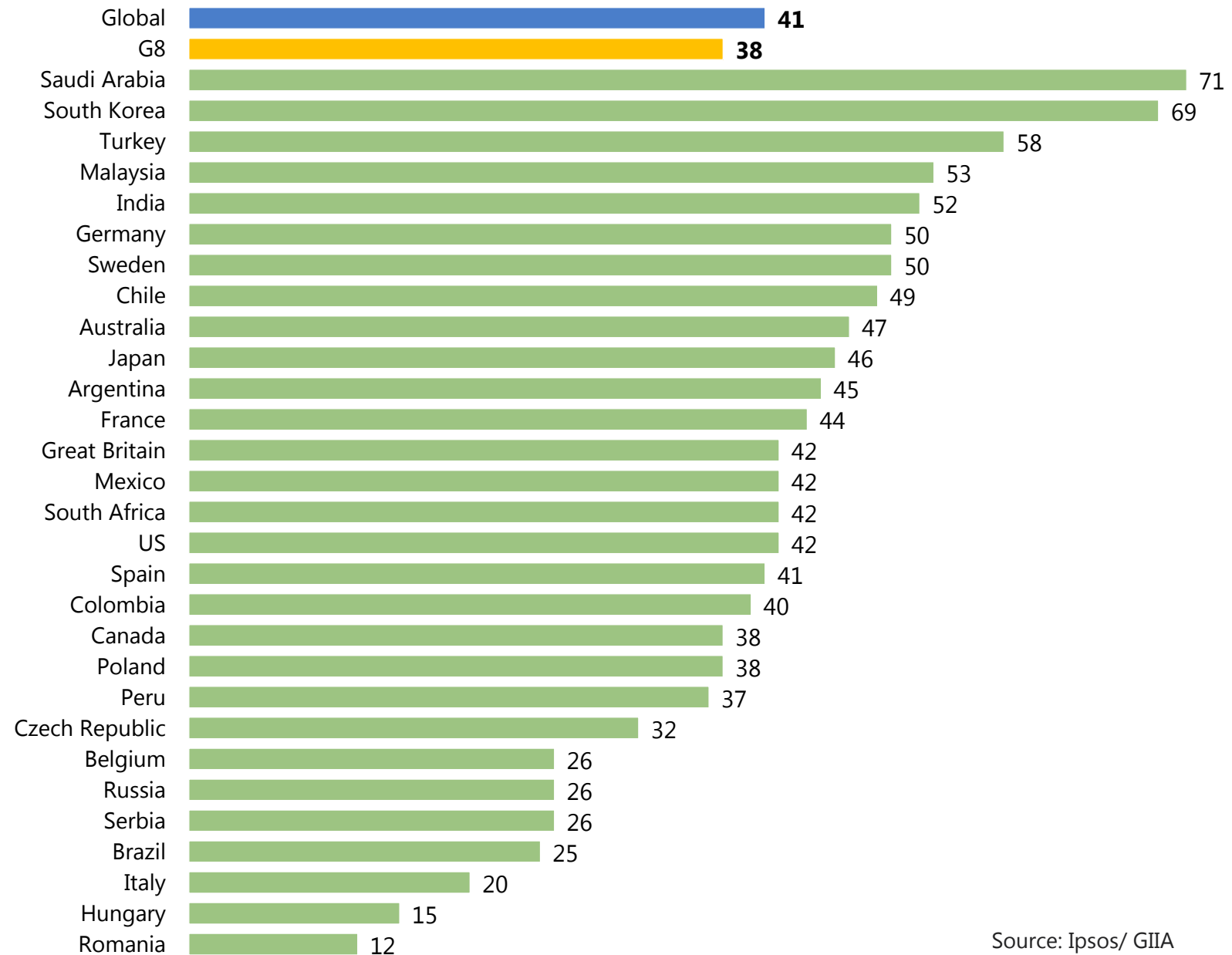

Source: Ipsos/ GIIA

Base: 19,786 adults (online), Aug-Sept 2018

# Rail

**Q. These next questions are about different types of infrastructure. Please indicate how good or poor you rate the current quality of each one in [COUNTRY]...**

**Rail infrastructure (track/stations)**

**% very/fairly good**

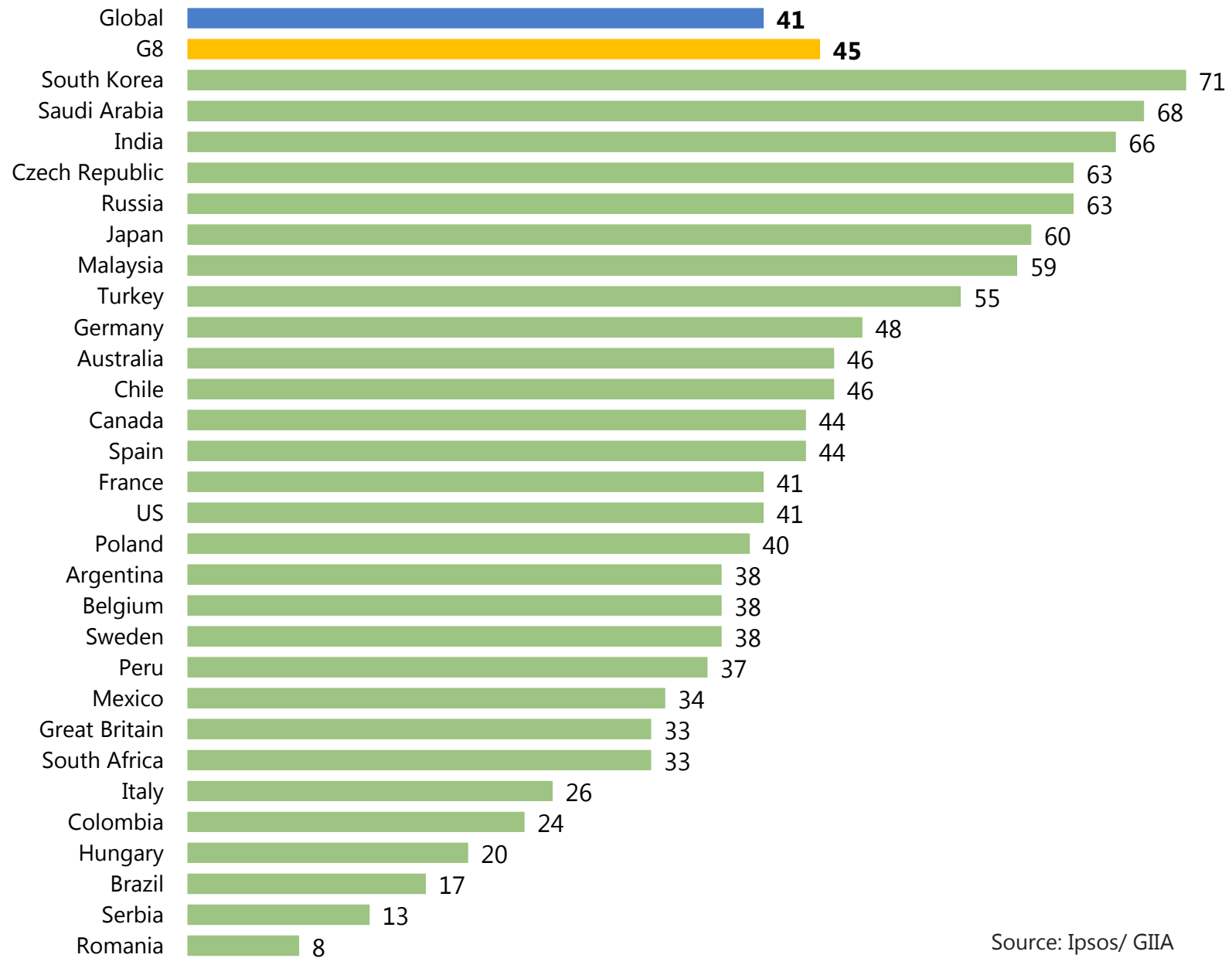

Source: Ipsos/ GIIA

Base: 19,786 adults (online), Aug-Sept 2018

# Housing supply

**Q. These next questions are about different types of infrastructure.**

**Please indicate how good or poor you rate the current quality of each one in [COUNTRY]...**

## New housing supply

**% very/fairly good**

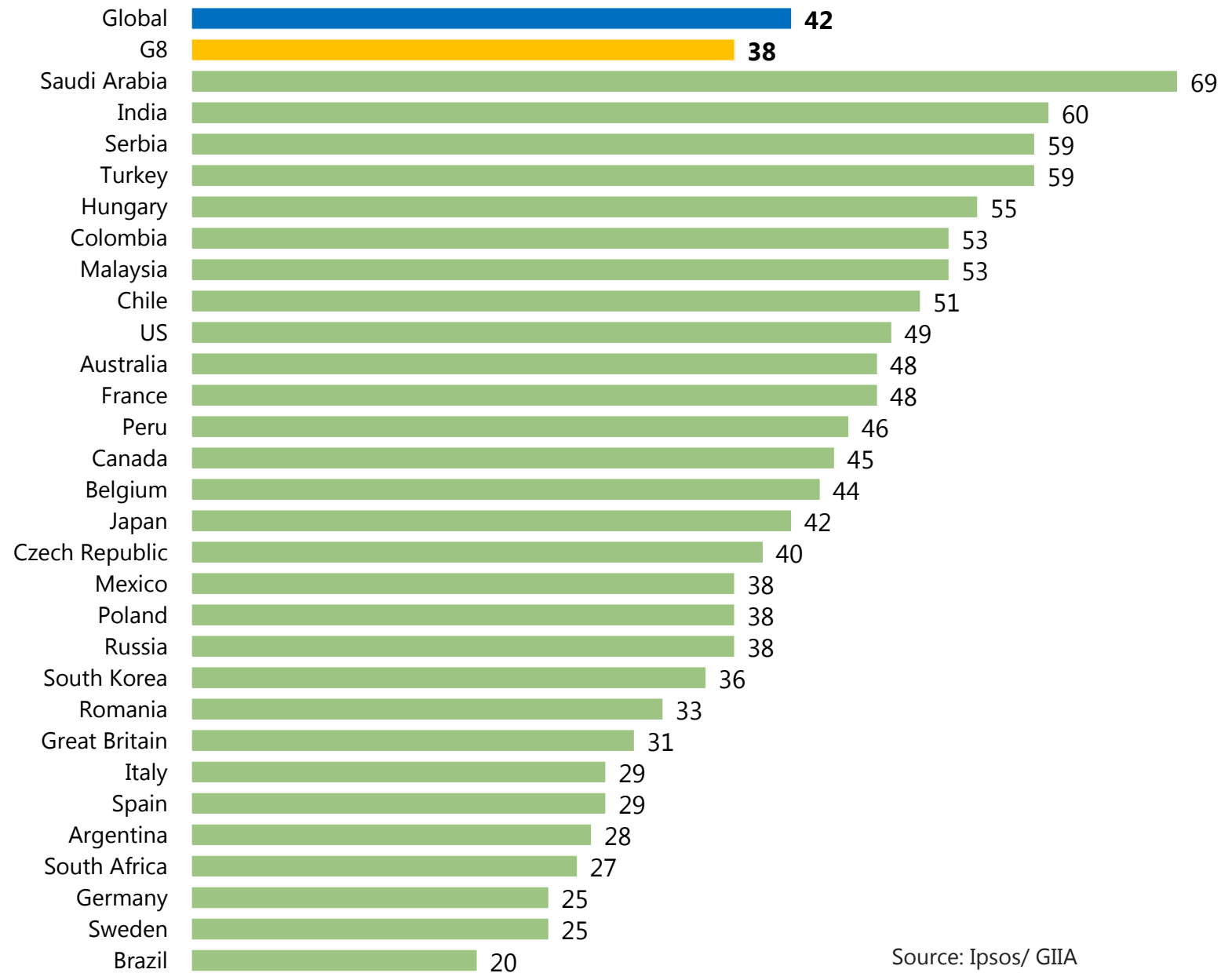

Source: Ipsos/ GIIA

Base: 19,786 adults (online), Aug-Sept 2018

# Flood defences

**Q. These next questions are about different types of infrastructure.**

**Please indicate how good or poor you rate the current quality of each one in [COUNTRY]...**

## Flood defences

**% very/fairly good**

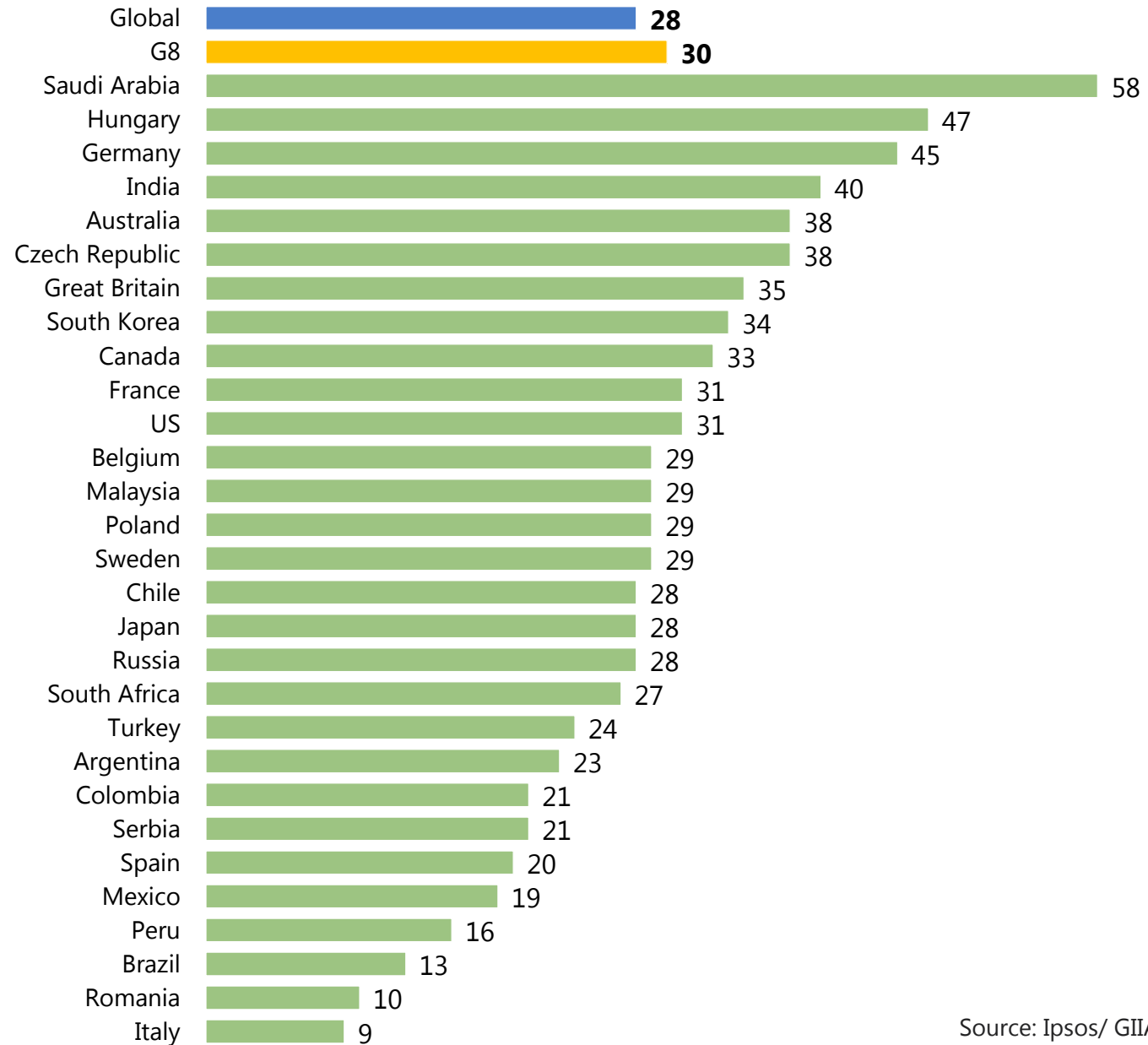

Source: Ipsos/ GIIA

Base: 19,786 adults (online), Aug-Sept 2018



# Energy

**Q. These next questions are about different types of infrastructure.**

**Please indicate how good or poor you rate the current quality of each one in [COUNTRY]...**

**Energy-generation infrastructure**

**% very/fairly good**

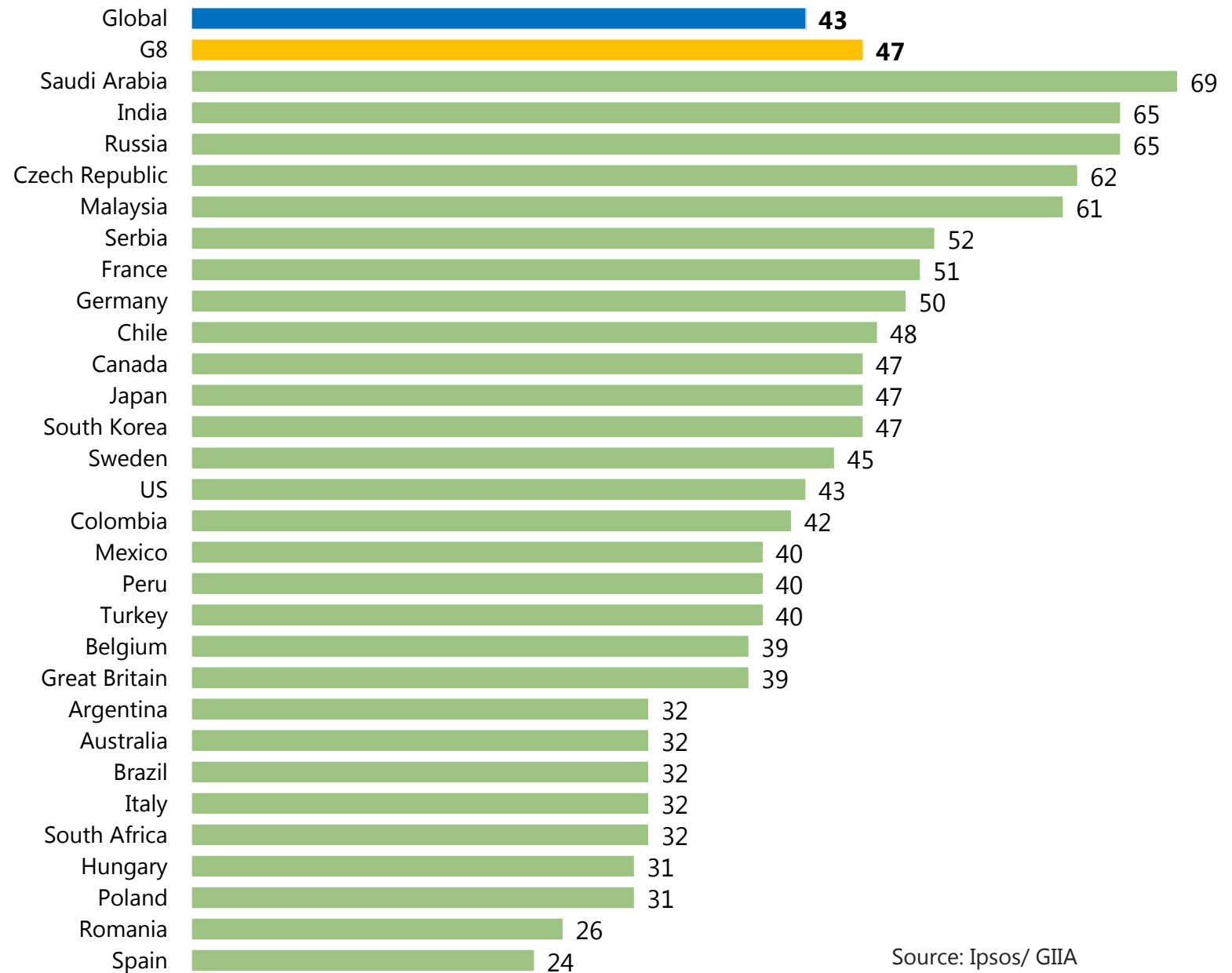

Source: Ipsos/ GIIA

Base: 19,786 adults (online), Aug-Sept 2018

# Nuclear

**Q. These next questions are about different types of infrastructure. Please indicate how good or poor you rate the current quality of each one in [COUNTRY]...**

**Nuclear infrastructure to generate energy**

**% very/fairly good**

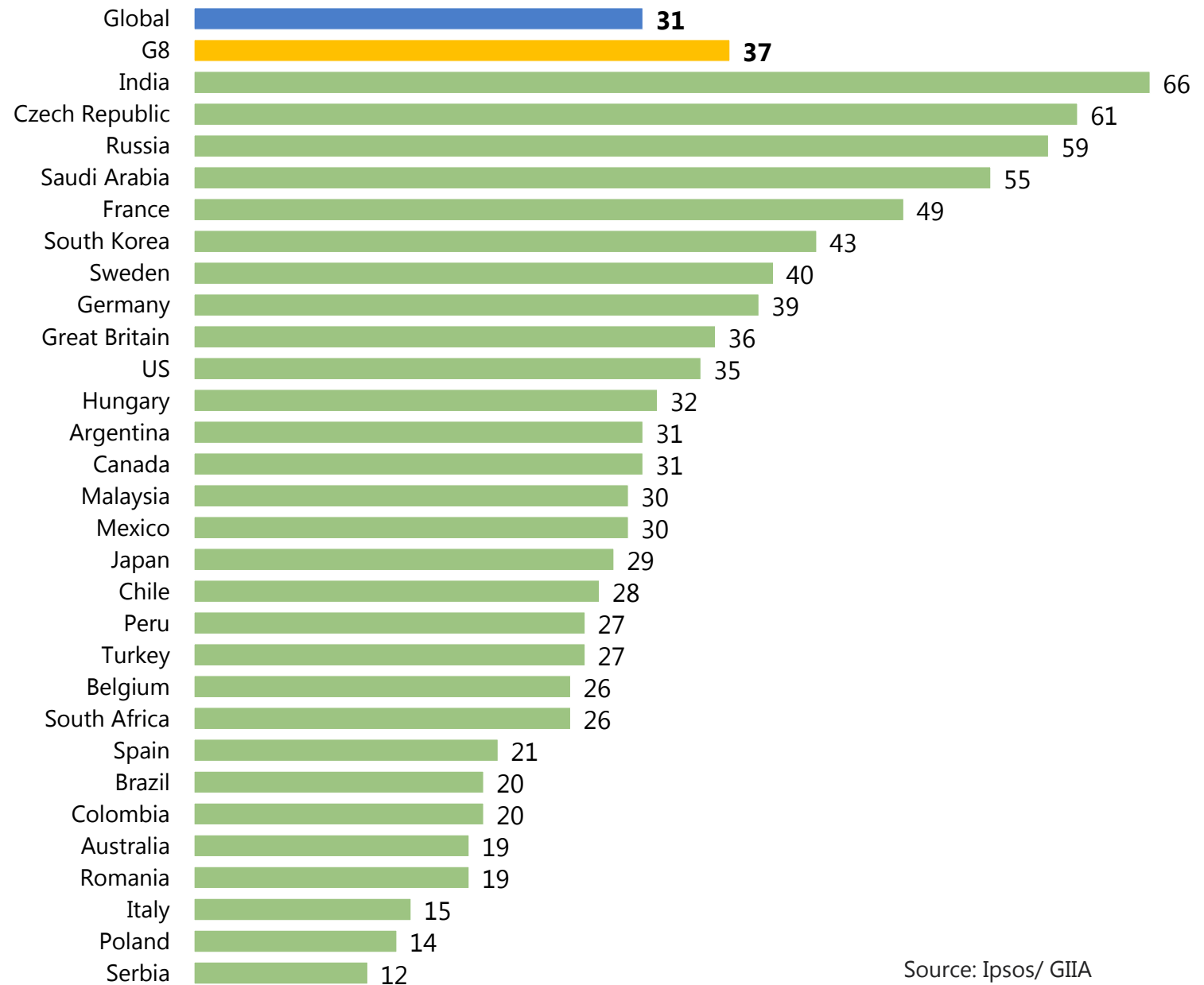

Source: Ipsos/ GIIA

Base: 19,786 adults (online), Aug-Sept 2018

# Digital

**Q. These next questions are about different types of infrastructure.**

**Please indicate how good or poor you rate the current quality of each one in [COUNTRY]...**

**Digital infrastructure such as high speed broadband, full fibre network (FTTP), 5G\***

**% very/fairly good**

\* Asked as 'Digital infrastructure such as high speed broadband' in 2016 and 2017

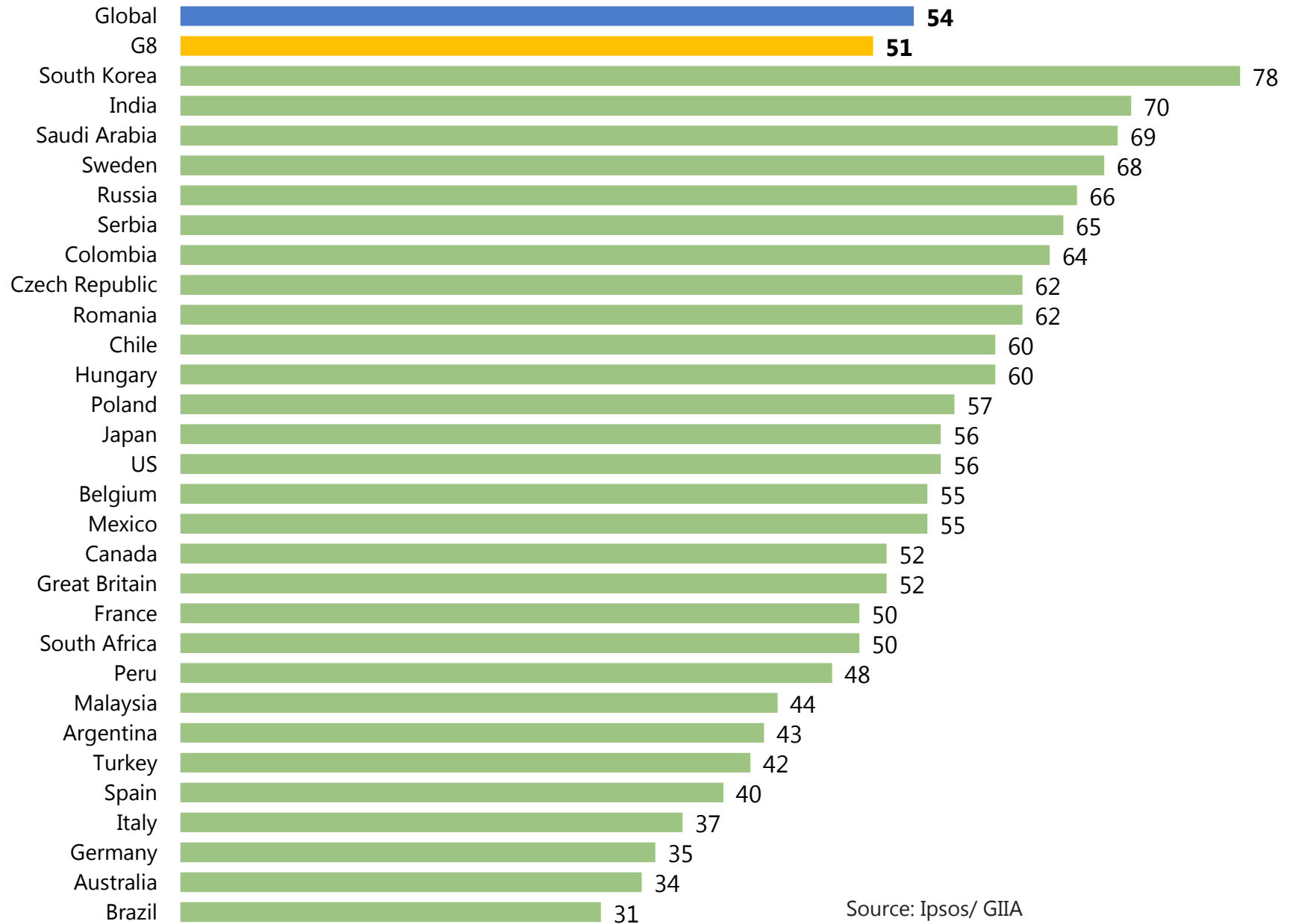

Source: Ipsos/ GIIA

Base: 19,786 adults (online), Aug-Sept 2018

# Water supply

## & sewerage

**Q. These next questions are about different types of infrastructure. Please indicate how good or poor you rate the current quality of each one in [COUNTRY]...**

### Water supply and sewerage

**% very/fairly good**

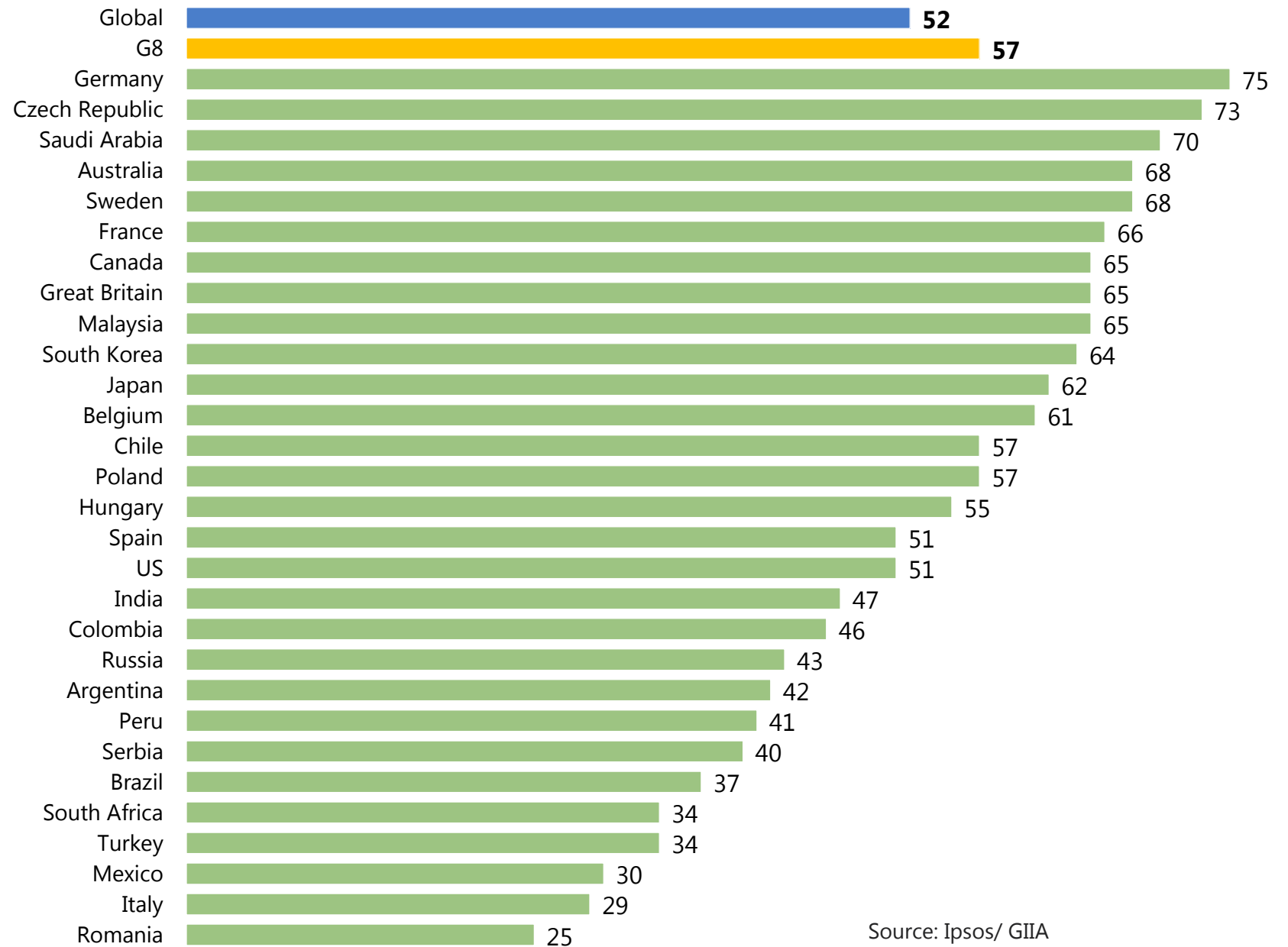

Source: Ipsos/ GIIA

Base: 19,786 adults (online), Aug-Sept 2018

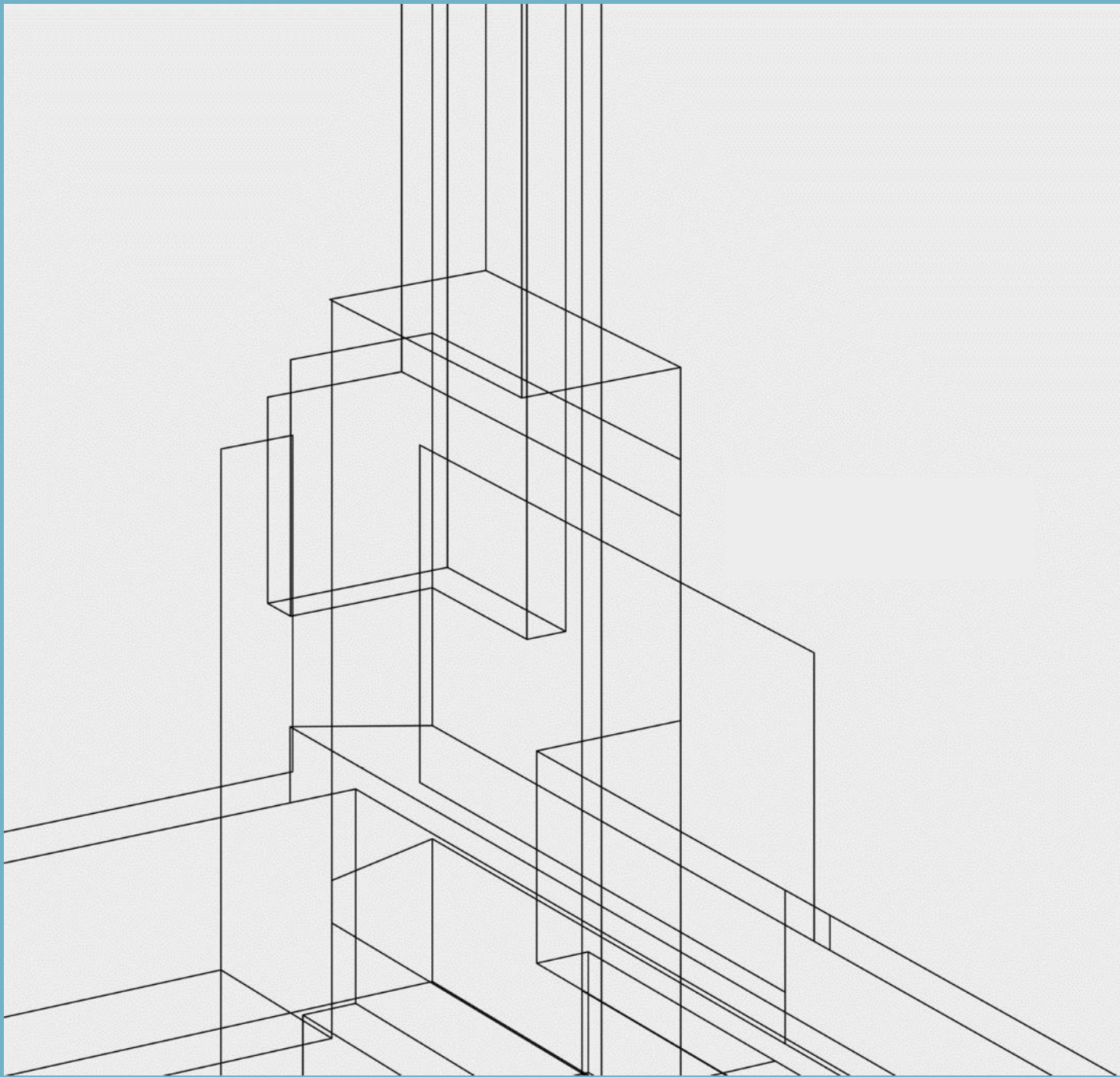

# Priorities

# Global and G8: Priorities

**Q. Which of these types of infrastructure, if any, do you think should be made a priority for investment for... [COUNTRY]?**

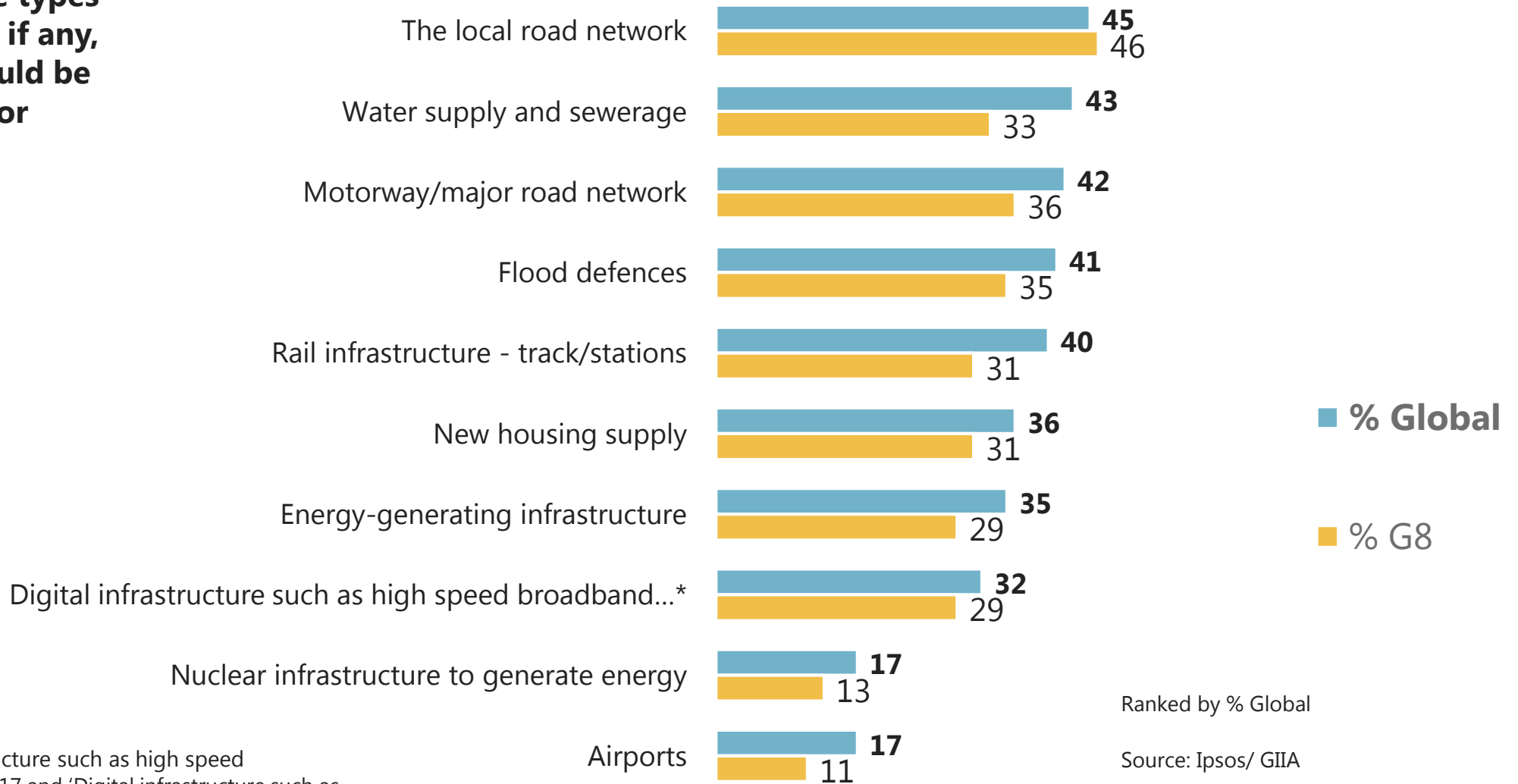

\* Asked as 'Digital infrastructure such as high speed broadband' in 2016 and 2017 and 'Digital infrastructure such as high speed broadband, full fibre networks (FTTP), 5G' in 2018

Ranked by % Global

Source: Ipsos/ GIIA

Base: 19,786 adults (online), Aug-Sept 2018

# G8 – Sectors: Ratings v priority

% very/fairly good

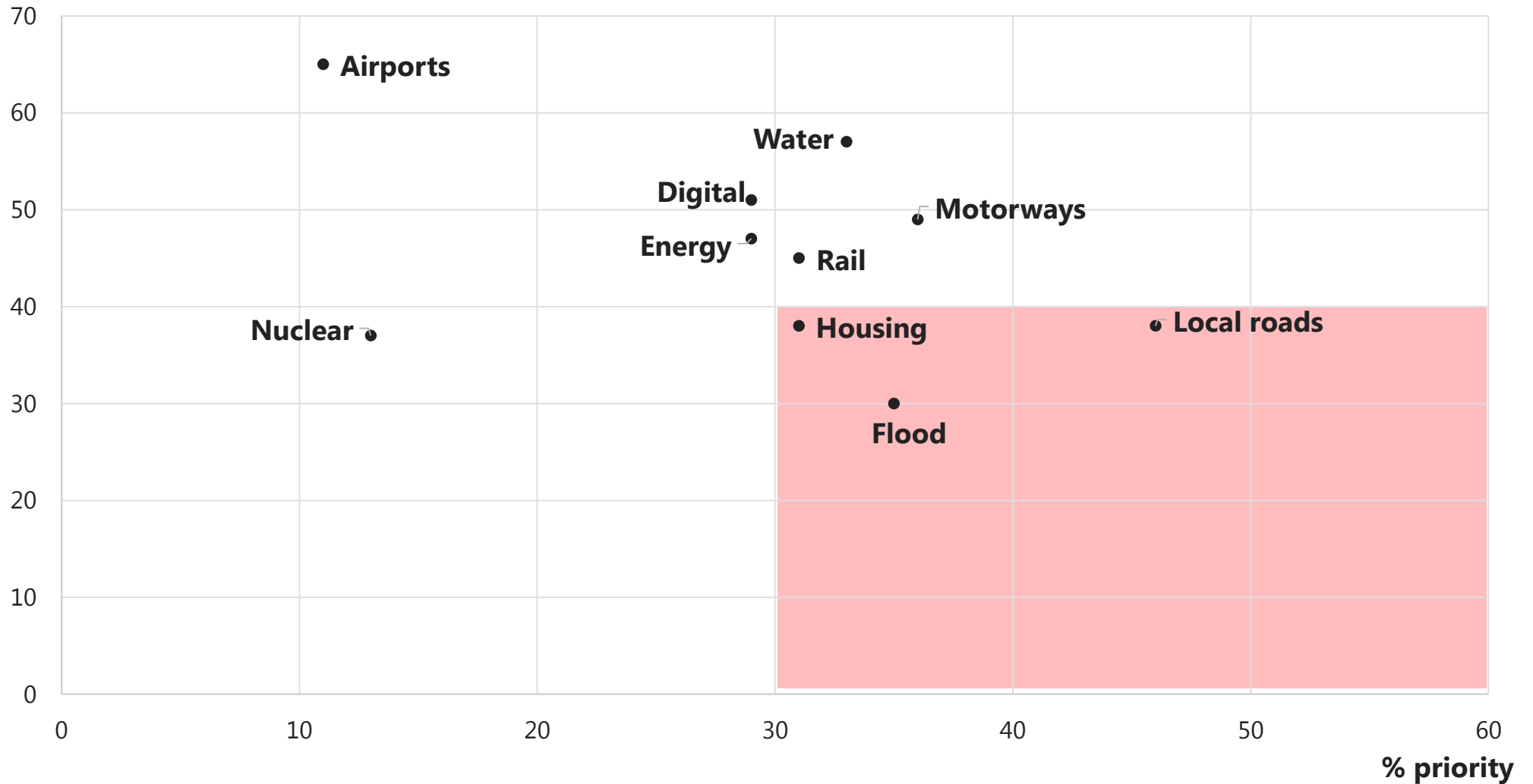

# Trends: Priorities – G8

**Q. Which of these types of infrastructure, if any, do you think should be made a priority for investment for... [COUNTRY]?**

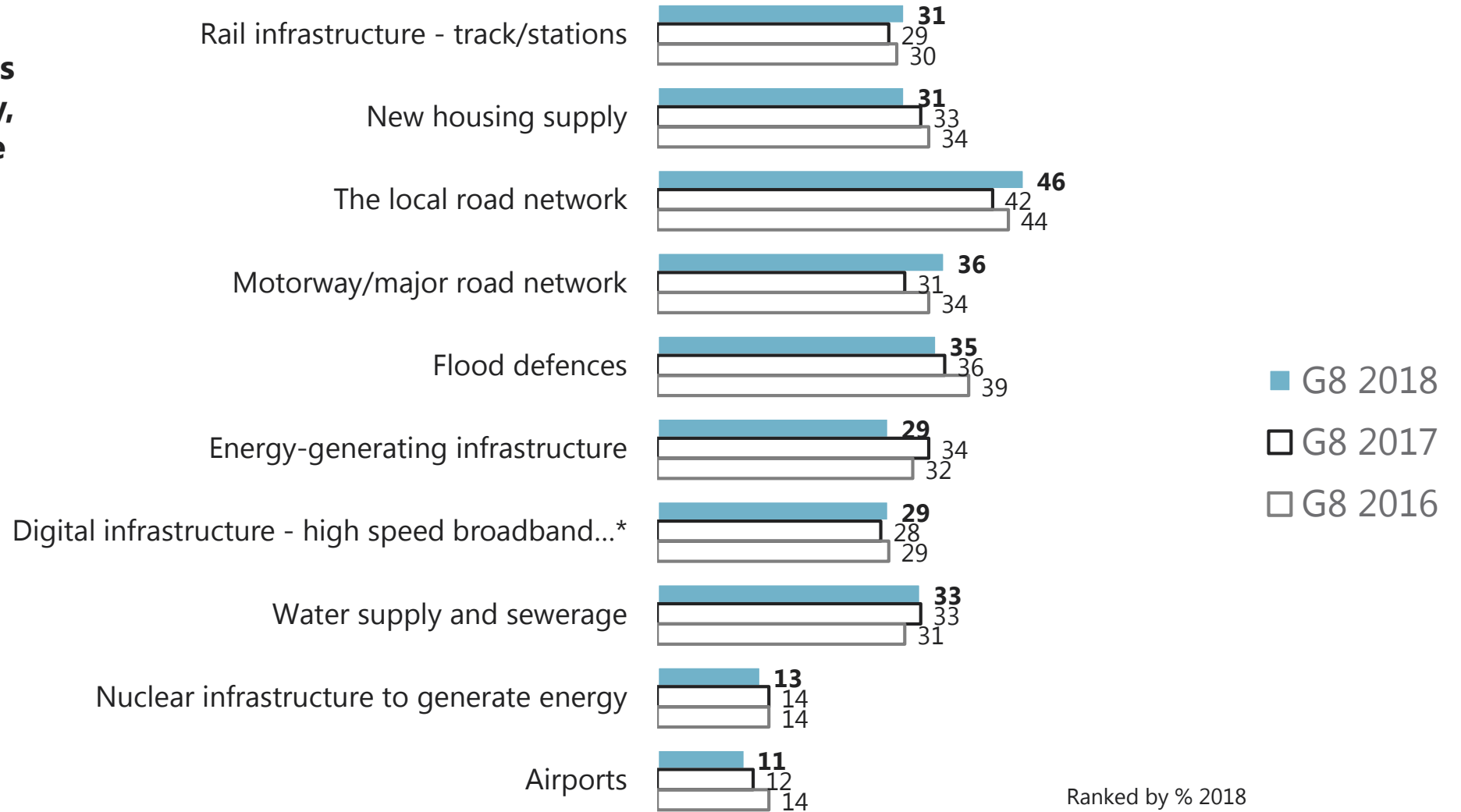

Ranked by % 2018

Source: Ipsos/ GIIA

Base: 19,786 adults (online), Aug-Sept 2018

\* Asked as 'Digital infrastructure such as high speed broadband' in 2016 and 2017 and 'Digital infrastructure such as high speed broadband, full fibre networks (FTTP), 5G' in 2018



# Trends: Priorities – G8

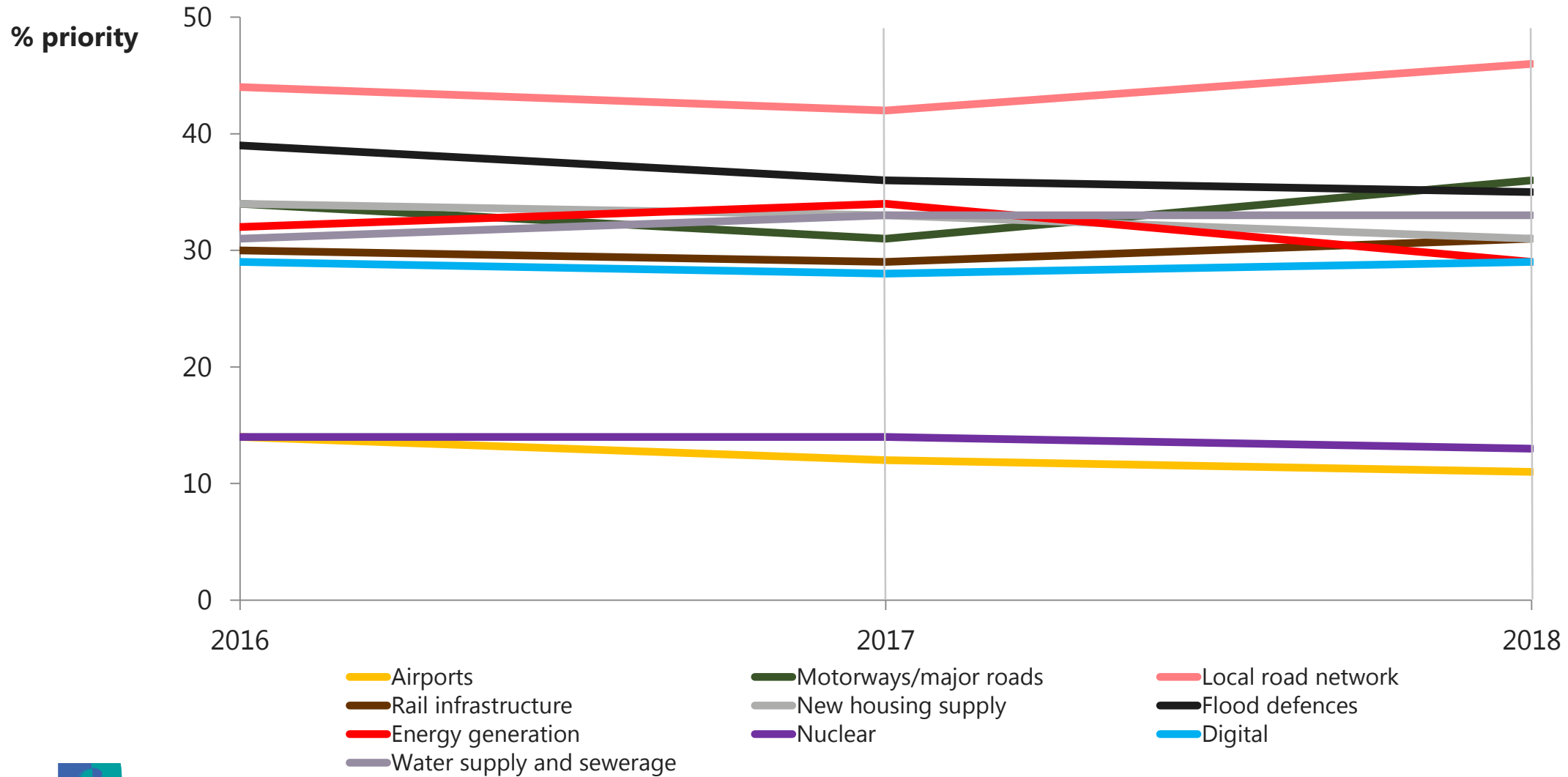

Source: Ipsos/ GIIA

Base: 19,786 adults (online), Aug-Sept 2018

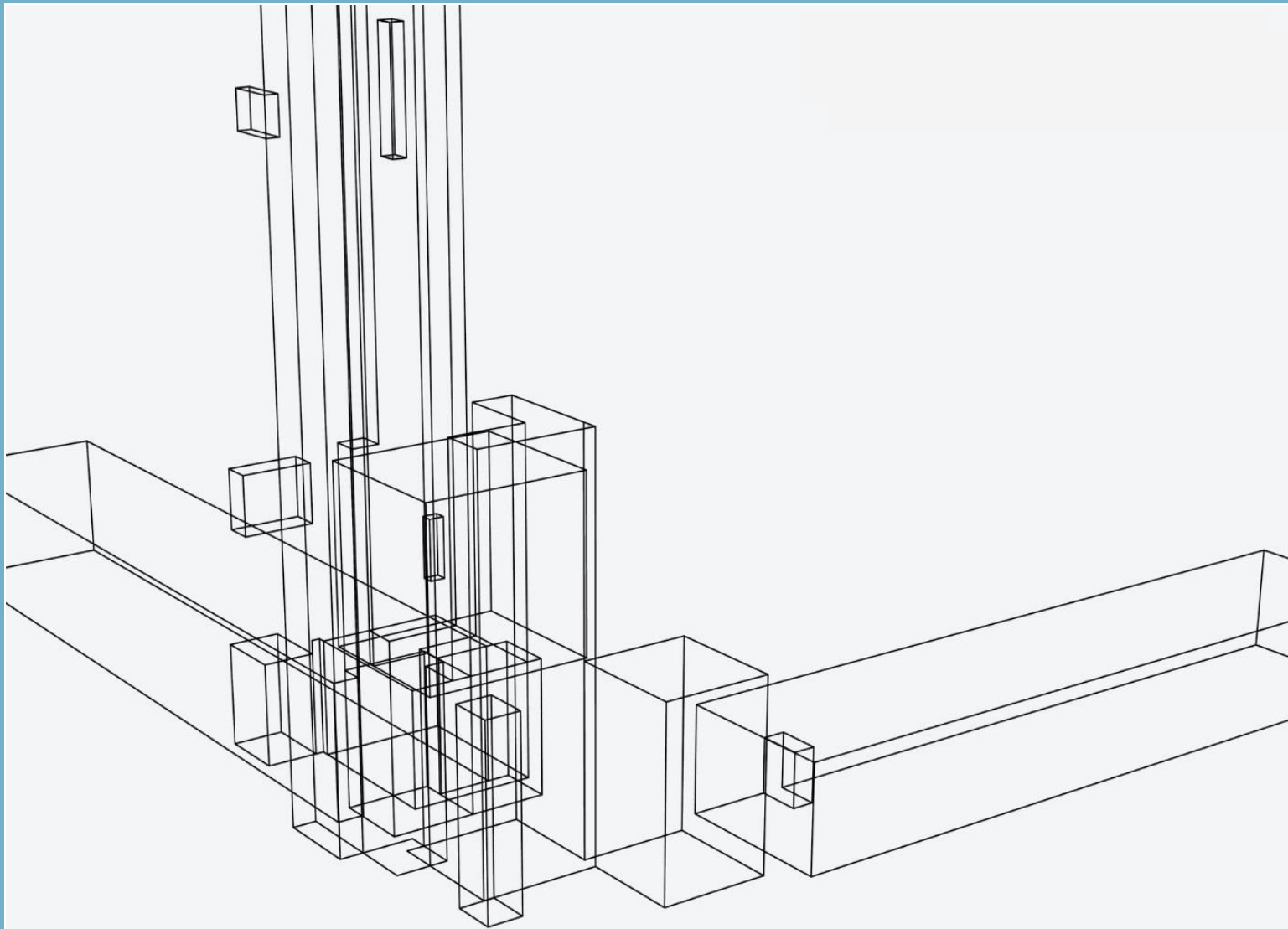

# Attitudes

# Global: Attitudes

**Q. To what extent do you agree or disagree...?**

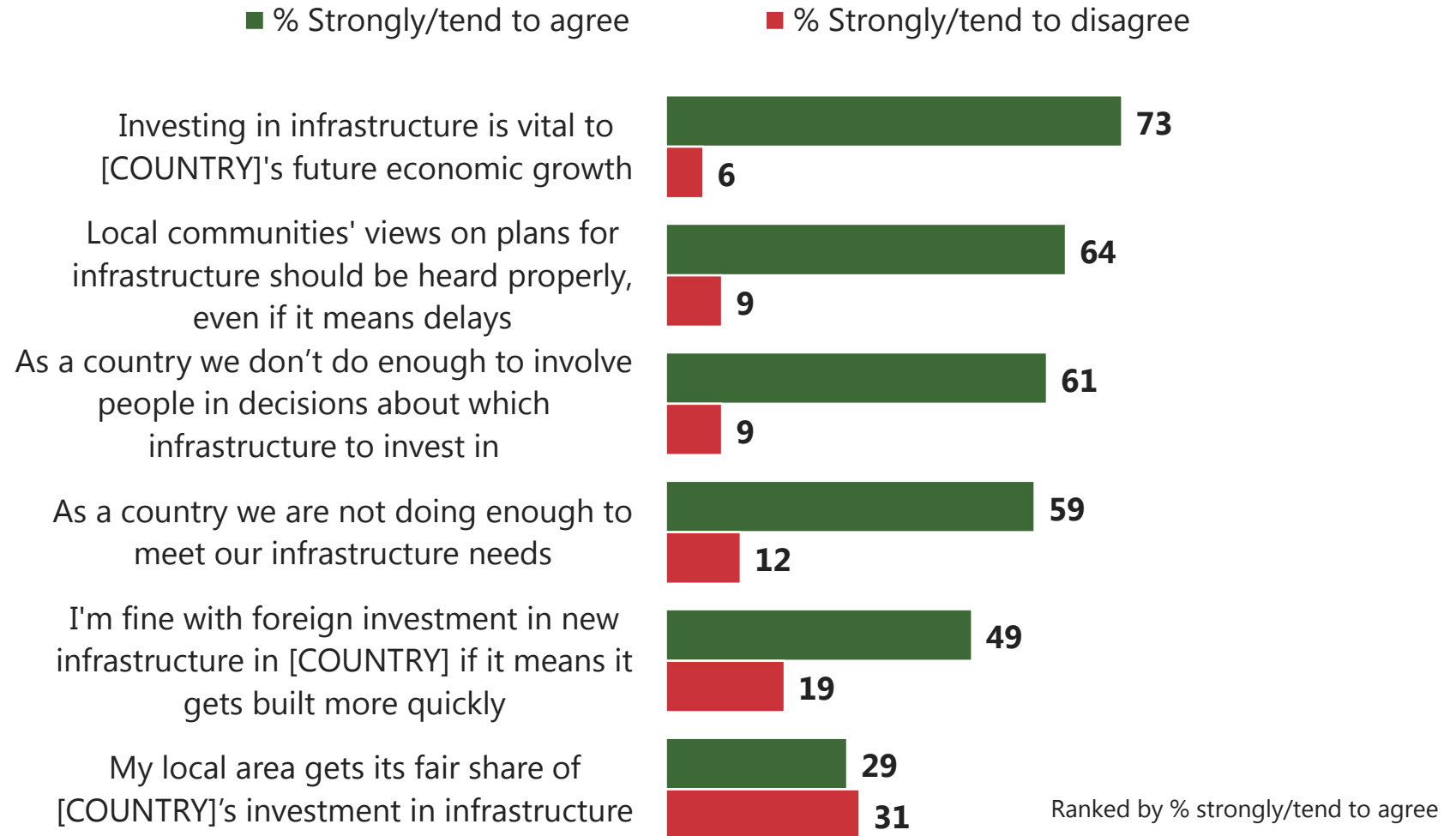

Source: Ipsos/ GIIA

Base: 19,786 adults (online), Aug-Sept 2018

# G8: Attitudes

**Q. To what extent do you agree or disagree...?**

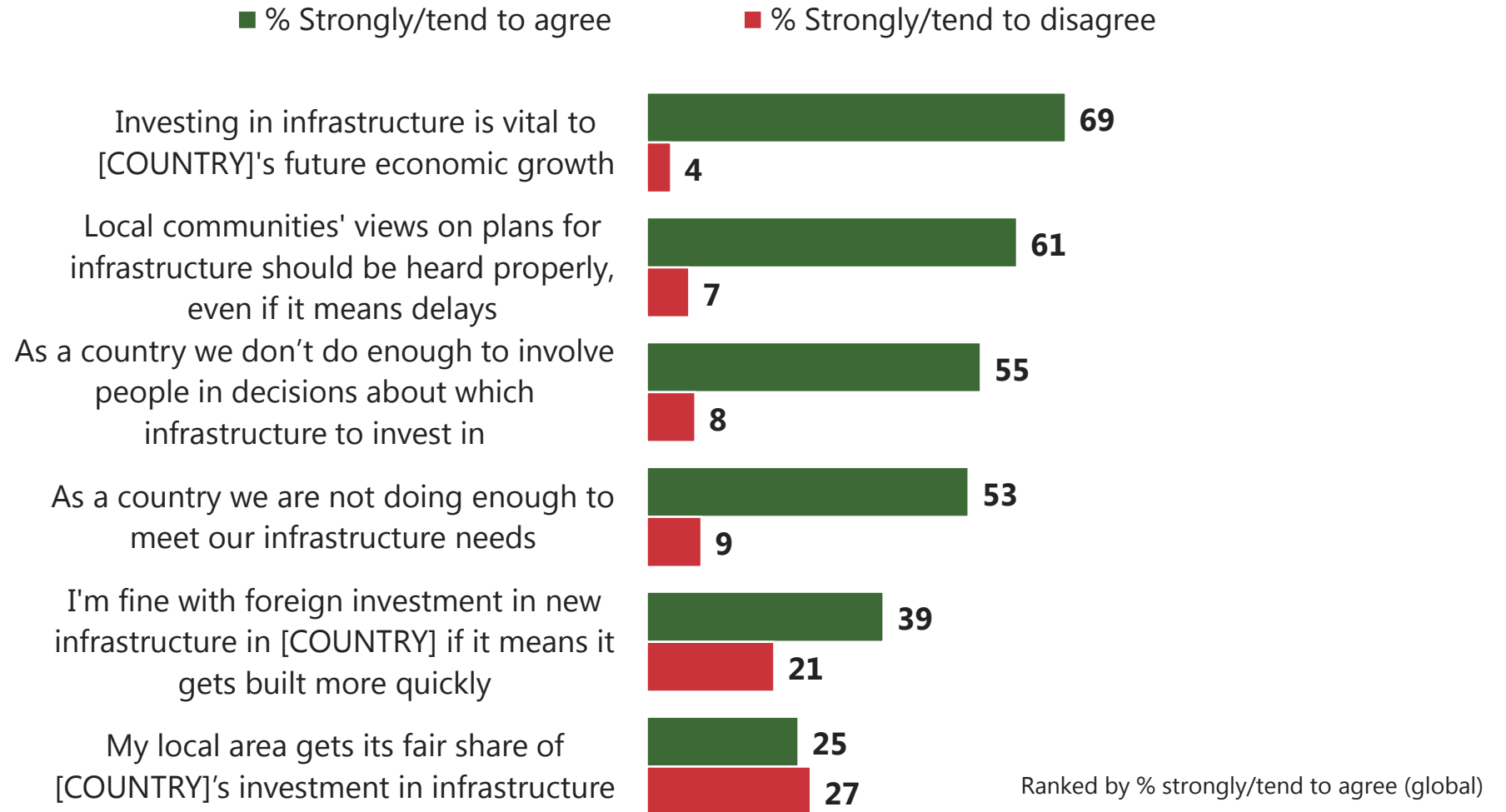

Source: Ipsos/ GIIA

Base: 19,786 adults (online), Aug-Sept 2018

# Doing enough?

**Q. To what extent do you agree or disagree...?**

**As a country we are not doing enough to meet our infrastructure needs**

**% strongly/tend to agree**

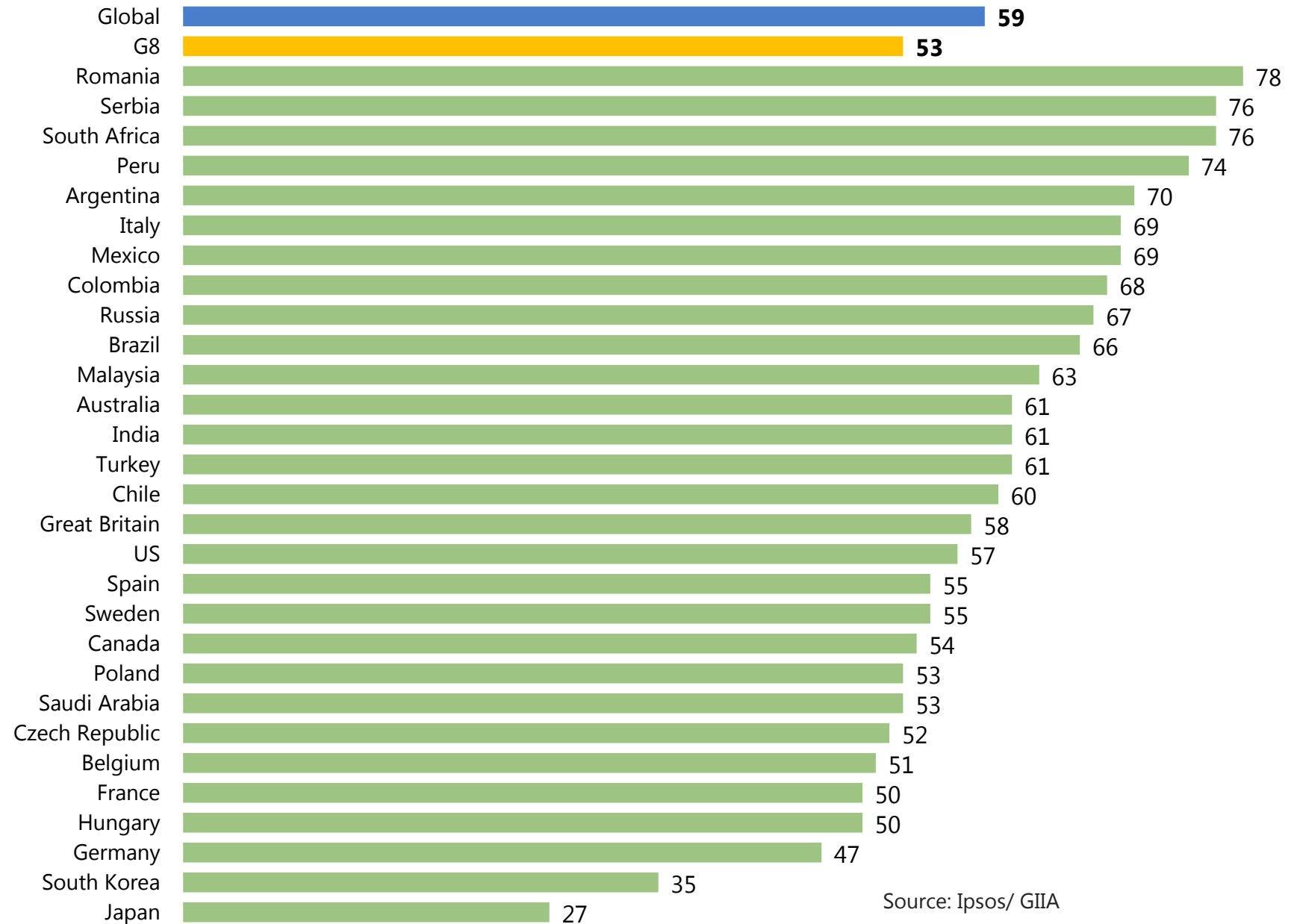

Source: Ipsos/ GIIA

Base: 19,786 adults (online), Aug-Sept 2018

# Investment vital

**Q. To what extent do you agree or disagree...?**

**Investing in infrastructure is vital to [COUNTRY]'s future economic growth**

**% strongly/tend to agree**

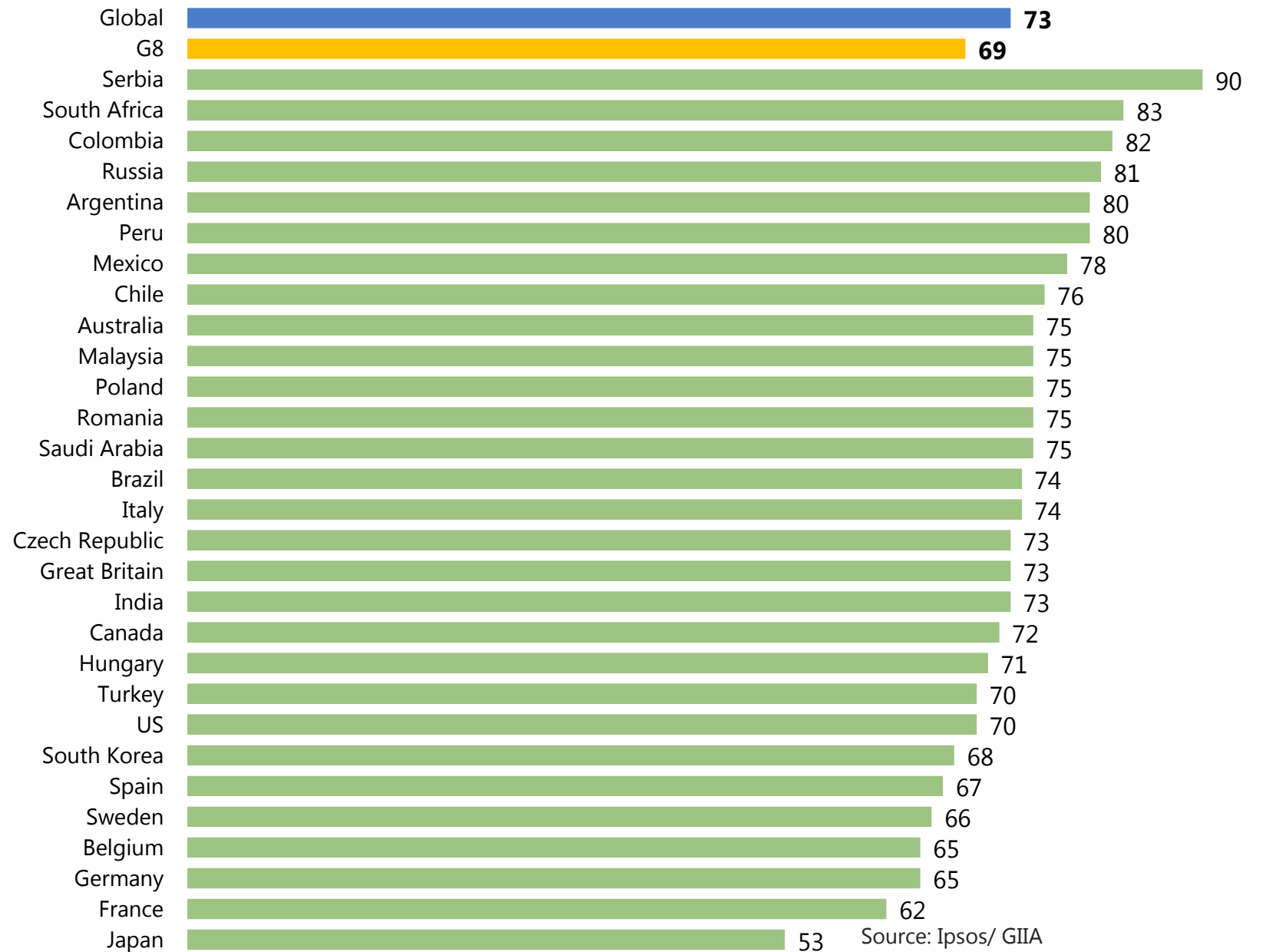

Source: Ipsos/ GIIA

Base: 19,786 adults (online), Aug-Sept 2018

# Fair share

**Q. To what extent do you agree or disagree...?**

**My local area gets its fair share of [COUNTRY]'s investment in infrastructure**

**% strongly/tend to agree**

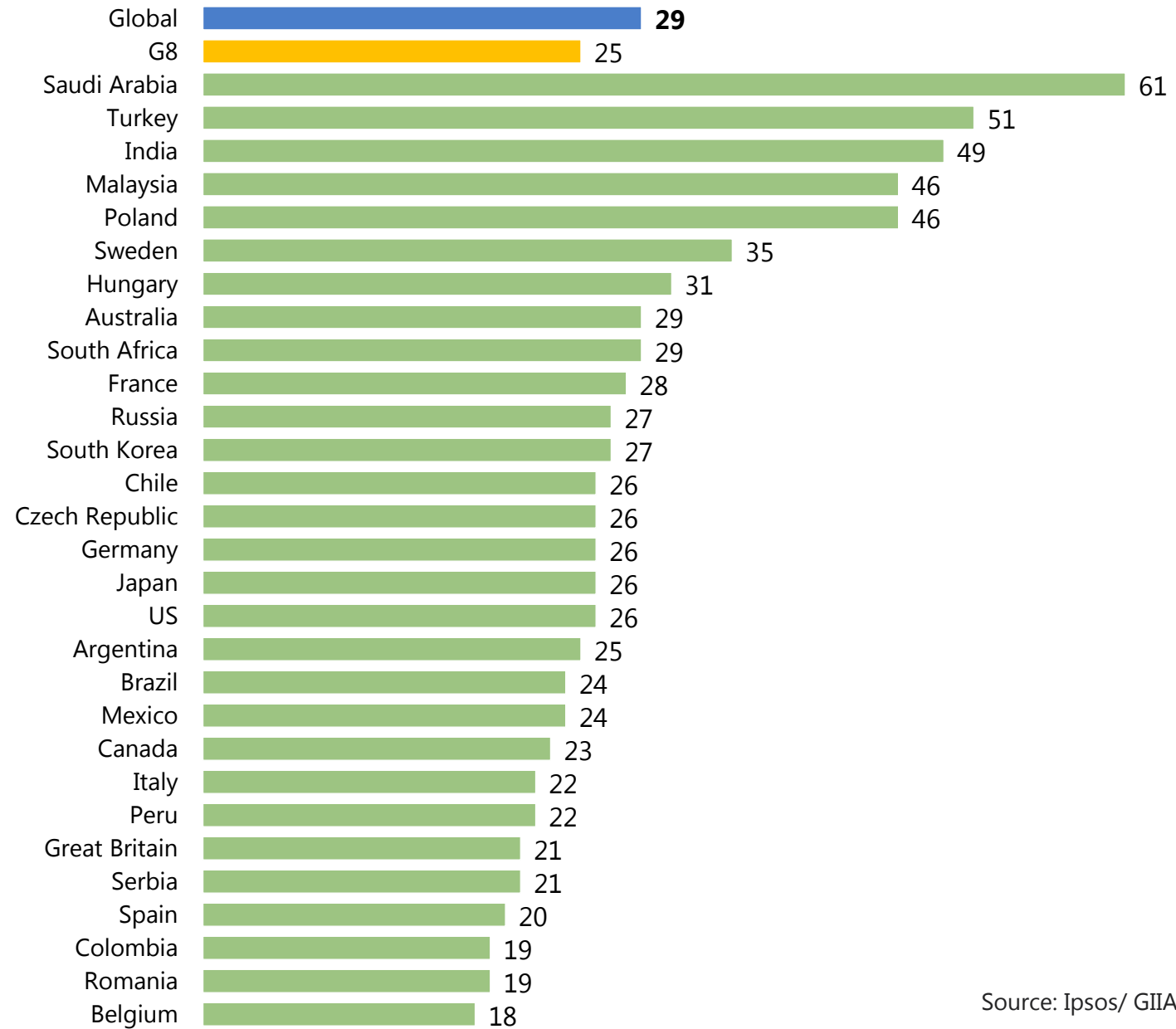

Source: Ipsos/ GIIA

Base: 19,786 adults (online), Aug-Sept 2018

# Local communities

**Q. To what extent do you agree or disagree...?**

**Local communities' views on plans for infrastructure should be heard properly, even if it means delays**

**% strongly/tend to agree**

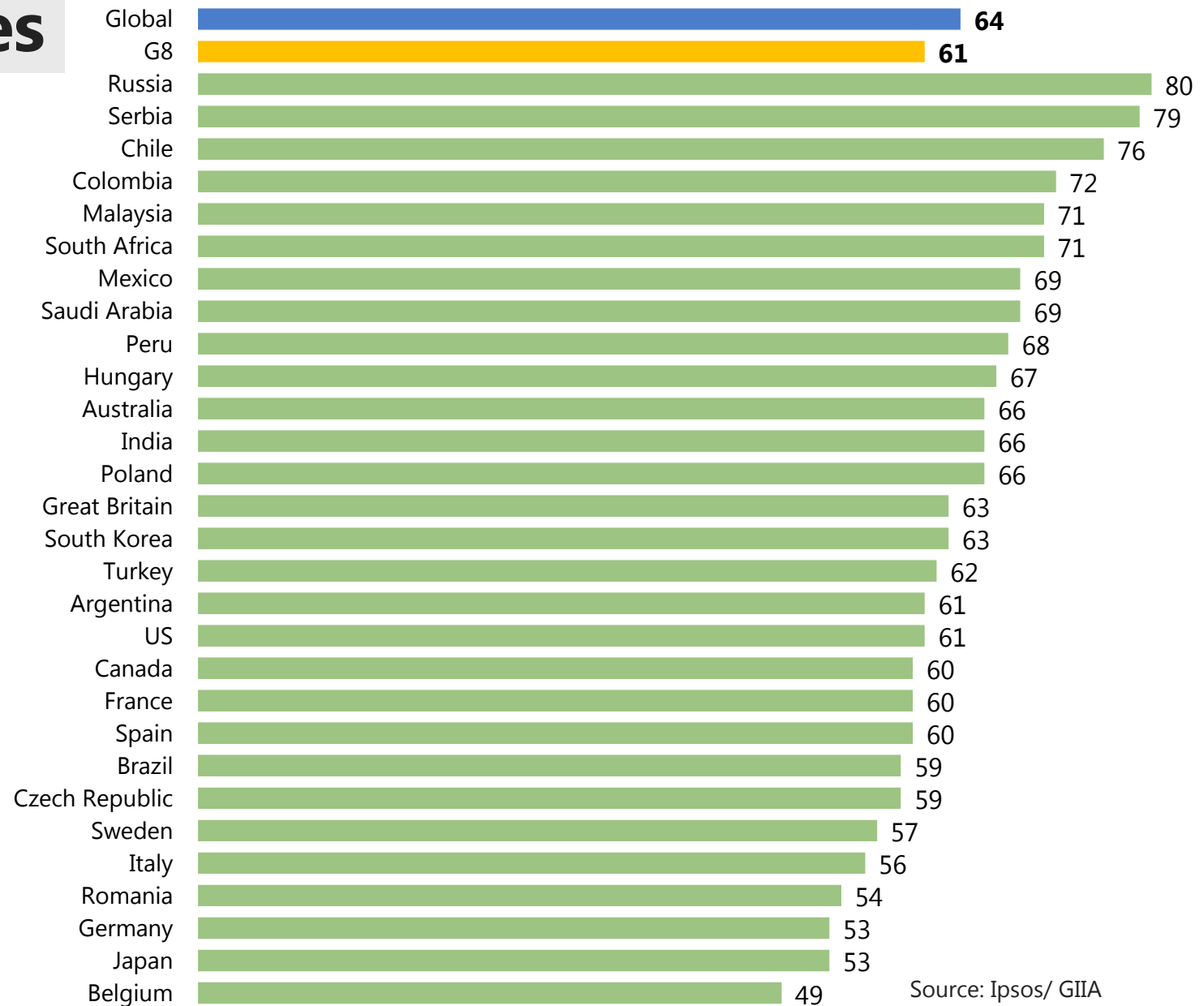

Source: Ipsos/ GIIA

Base: 19,786 adults (online), Aug-Sept 2018



# Foreign investment

**Q. To what extent do you agree or disagree...?**

**I'm fine with foreign investment in new infrastructure in [COUNTRY] if it means it gets built more quickly**

**% strongly/tend to agree**

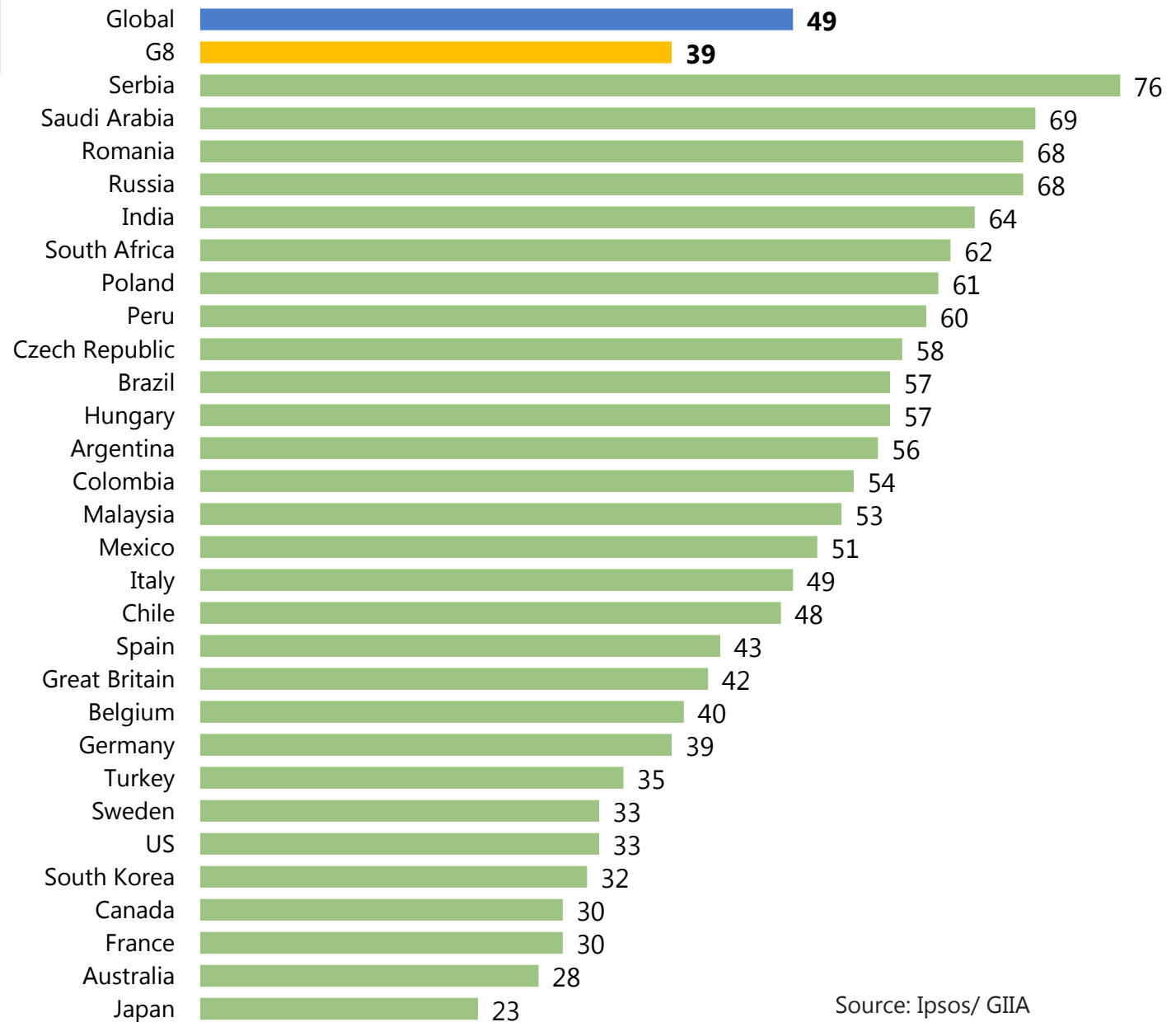

Source: Ipsos/ GIIA

Base: 19,786 adults (online), Aug-Sept 2018

# Involving people

**Q. To what extent do you agree or disagree...?**

**As a country we don't do enough to involve people in decisions about which infrastructure to invest in**

**% strongly/tend to agree**

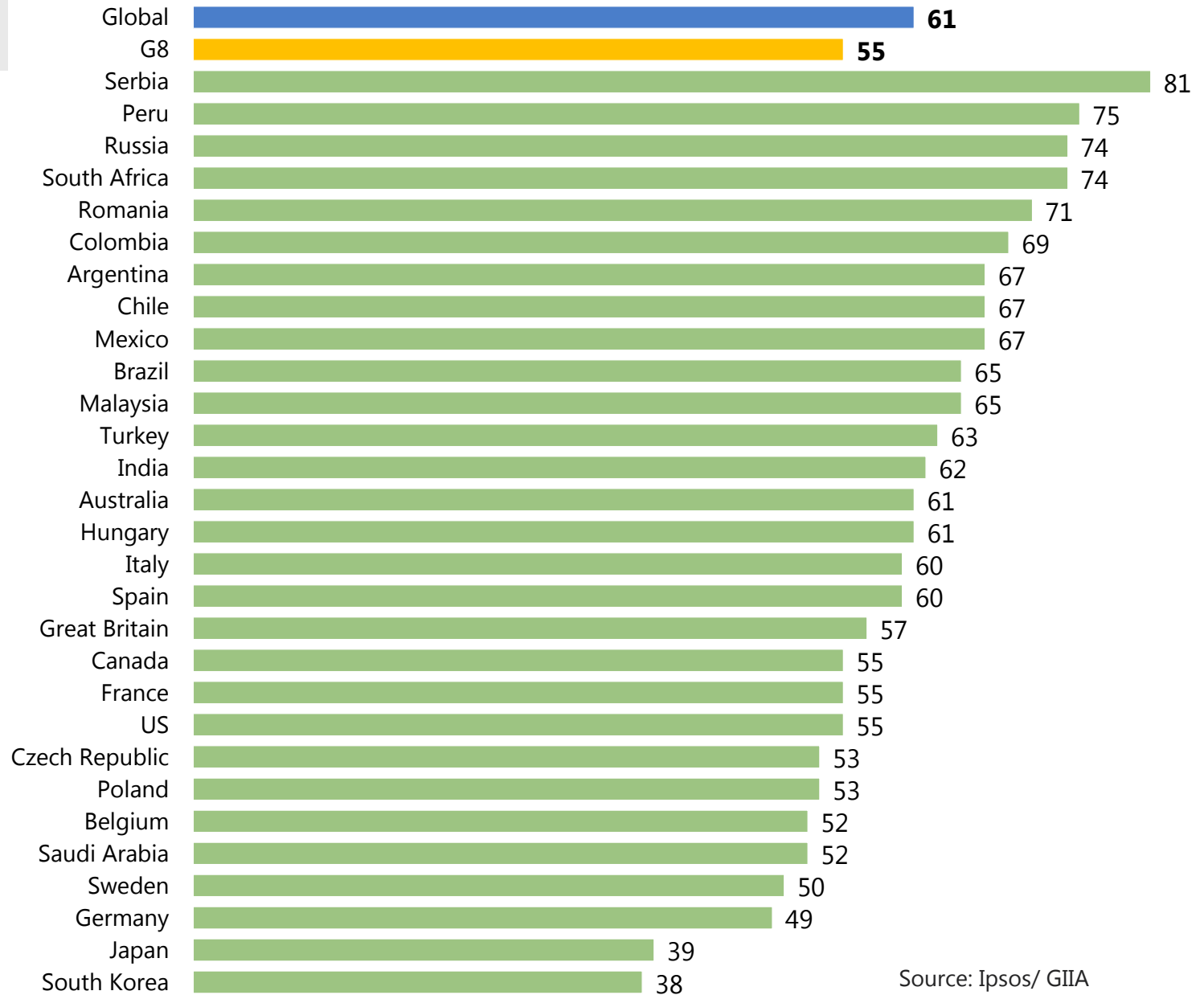

Source: Ipsos/ GIIA

Base: 19,786 adults (online), Aug-Sept 2018

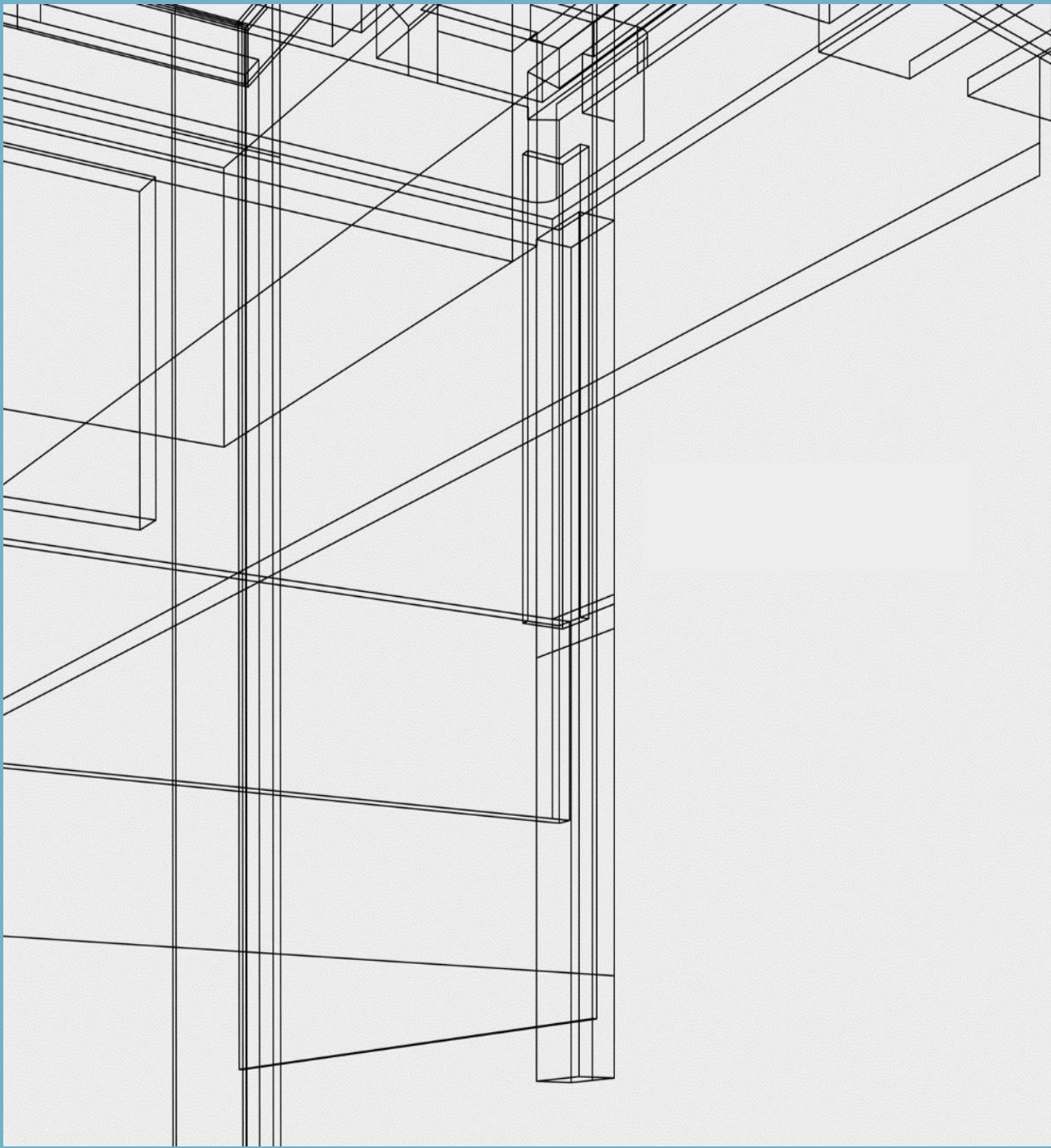

# Key findings

# Key findings

- Globally, overall ratings of infrastructure split approximately one third positive, one third negative, and one third neutral or don't know.
- This varies by region; e.g. there is a net *negative* margin of 11 percentage points in Europe but a *positive* one of 18 points in the APAC region.
- Satisfaction is on a downward trajectory among the G8 and European countries included in the survey.
- Several sectors are prioritised fairly equally by publics across 28 countries with the local road network top by a small 2 point margin above water supply and sewerage (45% and 43% respectively).
- Among sectors, airports are the most positively rated with flood defences and nuclear energy rated most negatively (29% are neutral on the latter – the highest for any sector).
- There is a strongly held conviction that infrastructure is vital to future economic growth but also a sense that people are insufficiently involved in decision-making and that areas do not get equitable returns from investment.

## Global

## G8

- Compared to the global average, publics across the G8 are relatively more positive about rail, flood defences and energy-generation, nuclear and water supply and sewerage.
- They are less positive about digital infrastructure, new housing supply, local roads and motorways.
- Most of the G8 countries are performing worse in terms of overall satisfaction than ratings of individual sectors. Some are performing as well or better than others despite having similar GCI (infrastructure) ratings.
- The stand-out priority is the local road network, chosen by 45% (motorways is the next highest at 36%). This has been the top G8 priority since 2016.
- G8 citizens are strongly of the view that infrastructure is vital to future economic growth but a majority think that their country is not doing enough to meet infrastructure needs.
- Publics are less sure that people are sufficiently involved in decision-making and that areas do get equitable returns from investment.

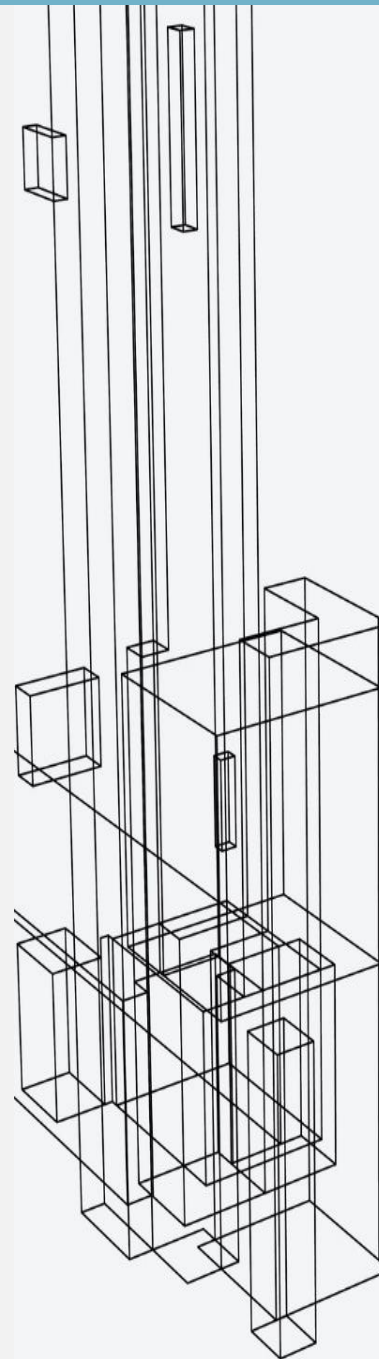



**Further**

**information**



**Ipsos MORI**  
Social Research Institute

**[Ben.Marshall@ipsos.com](mailto:Ben.Marshall@ipsos.com)**

**[Hannah.Millard@ipsos.com](mailto:Hannah.Millard@ipsos.com)**



**[THoran@giia.net](mailto:THoran@giia.net)**

**[JPhillips@giia.net](mailto:JPhillips@giia.net)**